

PD980

8MP Pendant PTZ Camera

Quick Start Guide



Find additional manuals, the datasheet, the EU Declaration of Conformity, and the latest firmware for this product at:

<https://tkhsecurity.com/>



Unpack



Camera Unit

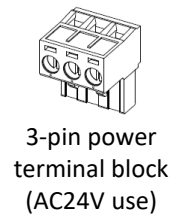

3-pin power terminal block (AC24V use)

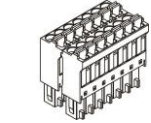

14-pin Alarm/Audio I/O terminal block



M4 security screw with rubber

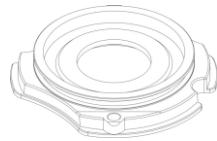

Grommet holder

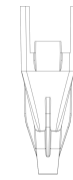

RJ45 insertion tool

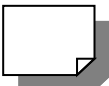

Quick Start Guide

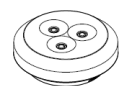

Grommet

Note 1: Subject to modification. Actual product and accessories may differ in appearance.

Installation Notices



CAUTION:

Installation shall be performed by qualified personnel only. Installation shall be in accordance with local procedures. Installation with poe shall be in unexposed networks. Battery replacement shall not be applied in view of the risk of explosion. If you use an external power supply, contact TKH Security to make sure that the power supply has the proper power specifications. Make sure that the power supply complies with LPS requirements. When installing the camera, hook up the camera with the anti-drop chain of the pendant to the anti-drop ring (see figure 1). For more information, contact TKH Security.

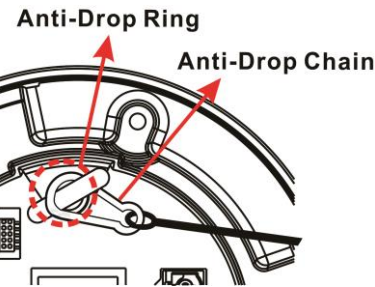

Figure 1 Position anti-drop ring and anti-drop chain

Connectors

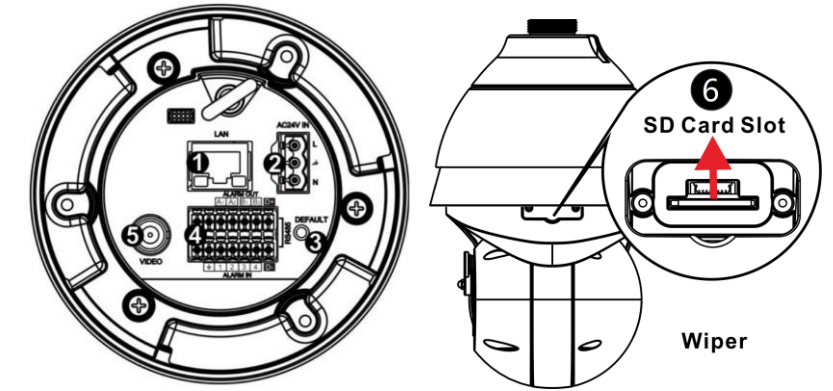

Figure 2 Camera Connectors

For the connector definitions, see table 1.



NOTE:

It is not recommended to continuously (24/7) record with the micro-SD card, as the camera may not support long-term continuous data read/write. Contact the manufacturer of the micro-SD card for information regarding the reliability and the life expectancy.

Connector Definition

No.	Connector	Definition
1	RJ-45 Port (Contact TKH Security for a compatible PoE injector.)	For network and PoE (802.3bt) connections
2	Power (AC24V)	AC24V power connection
3	Reset Button	Press the button with a proper tool for at least 20 seconds to restore the system.
4	Audio/Alarm I/O & RS-485	Audio/Alarm I/O & RS-485 connection
5	BNC	For analog video output
6	SD Card Slot	Insert the SD card into the card slot to store videos and snapshots. Do not remove the SD card when the camera is powered on.

Table 1 Connector Definition

Camera Cabling (1)

Power Connector (AC 24V)

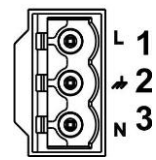

Pin	Definition
1	AC24V L
2	GND
3	AC24V N

Table 3 Pin definition for AC24V power connection



NOTE: In some cases, an ethernet crossover cable may be needed when connecting the camera directly to the pc. Check the status of the link indicator and the activity indicator LEDs. If the LEDs are unlit, check the LAN connection.
NOTE: Do not replace batteries of the camera. Risk of explosion may occur if the battery is replaced by an incorrect type.
NOTE: Leaving a camera in an extremely high temperature surrounding environment can result in an explosion or the leakage of flammable liquid or gas.
NOTE: Camera subjected to extremely low air pressure may result in an explosion or the leakage of flammable liquid or gas.
NOTE: The means of power cord of adapter should be connected to a socket-outlet with earthing connection.

Camera Cabling (2)

PoE and Ethernet cable connection

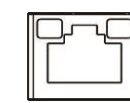

- The green link LED is lit when there is a good network connection.
- The orange network LED flashes to indicate that there is network activity.



WARNING: For "PoE" input connection, use only with UL listed I.T.E. with "PoE" output. Description for the "PoE" is intended to be connected to not exposed (outside plant) networks or equivalent statement in installation instructions.
POWER RATING: 24VAC, 50-60Hz, 3.26A shall be supplied by power adapter. 55VDC, 0.93A shall be supplied by "PoE" (802.3bt type 3 class 6).
NOTE: Explosion may occur due to disposal of a battery into fire or a hot oven, or mechanically crushing or cutting of a battery.
NOTE: The wiring of input terminal block should be installed by skilled personnel.
NOTE: Use wire size ranging from 16 to 24 AWG (and wire type: Cu) ONLY.
NOTE: The recommended tightening torque is 0.5 N-m.
NOTE: Use of controls or adjustments of performance or procedures other than those specified herein may result in hazardous radiation exposure.

Audio/Alarm I/O and RS-485 connection

See the diagram and the pin definitions below for the Audio/Alarm I/O and RS-485 connection.

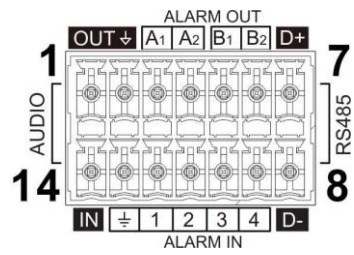
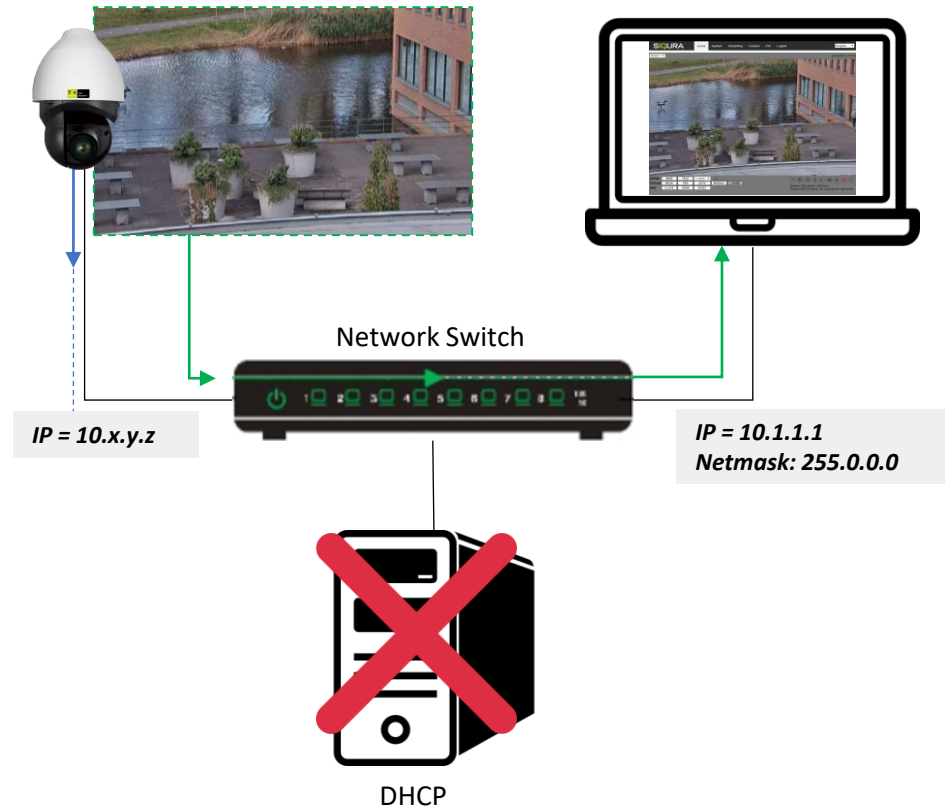

Figure 3 Diagram of Audio/Alarm I/O and RS-485 connection pins

Pin	Definition	Pin	Definition
1	Audio Out	8	RS-485 D-
2	GND (Audio I/O)	9	Alarm In 4
3	Alarm Out A1	10	Alarm In 3
4	Alarm Out A2	11	Alarm In 2
5	Alarm Out B1	12	Alarm In 1
6	Alarm Out B2	13	GND (Alarm I/O and RS-485)
7	RS-485 D+	14	Audio In

Table 3 Pin definitions for Audio/Alarm I/O and RS-485 connection

Accessing the camera



Auto detect with SDM2

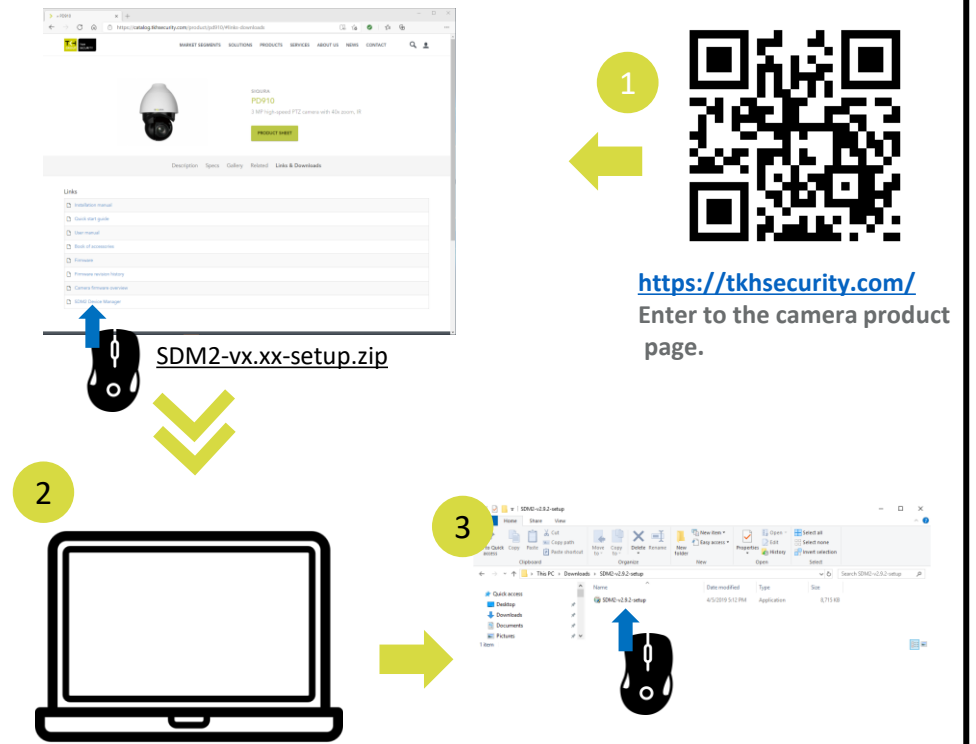

1st time camera login

Install browser-based viewer

Browser-based Viewer

Figure 4 shows the main page of the IP camera user interface.

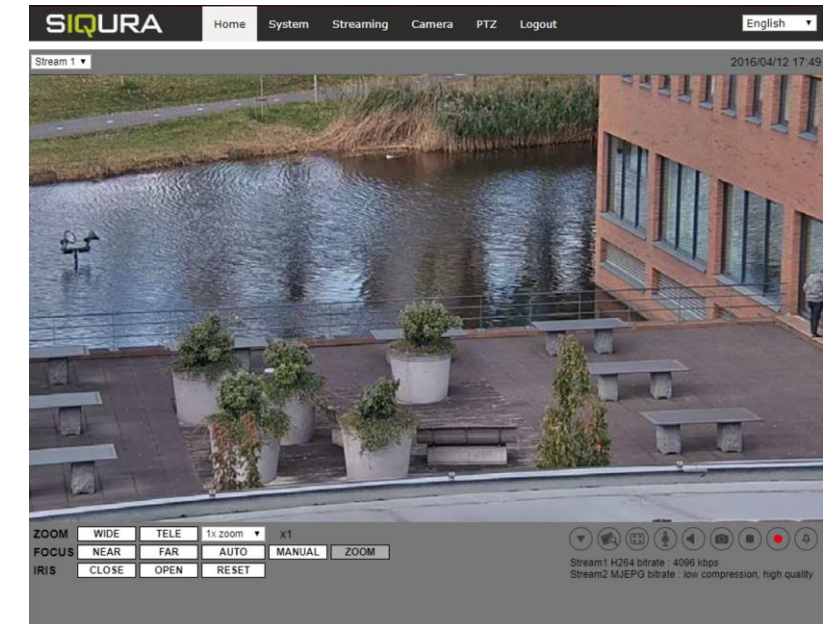

Figure 4 Main page IP camera user interface

Note 1: If the IE web interface is not showing video, you might need to open your firewall or set the OCX protocol to RTP-over-RTSP(TCP).