

VIDEO SECURITY 2015/16

SECURITY SOLUTIONS
BY GRUNDIG



FOR A GOOD REASON
GRUNDIG

MODERN VIDEO SECURITY SOLUTIONS

GRUNDIG SECURITY, BASED IN ERKRATH, NEAR DÜSSELDORF IN GERMANY, MAKES ADVANCED VIDEO SURVEILLANCE SYSTEMS FOR PROFESSIONAL APPLICATIONS. THE GRUNDIG BRAND IS RECOGNISED FOR ITS EXCEPTIONAL FUNCTIONALITY, QUALITY AND USER-FRIENDLY DESIGN.

THE GRUNDIG SURVEILLANCE PRODUCT RANGE INCLUDES CS MOUNT, BULLET, FIXED DOME AND PTZ DOME CAMERAS; DVR AND NVR CONTROL AND RECORDING SYSTEMS; LED BACKLIGHT MONITORS; AND NETWORK TRANSMISSION SYSTEMS. GRUNDIG OFFERS IP, ANALOGUE AND HD-SDI TECHNOLOGY SOLUTIONS WITH FULL HD OPTIONS.

GRUNDIG - WHAT REALLY MATTERS.



CONTENTS



IP CAMERAS	5
Overview IP Cameras	6
Box Cameras	8
Indoor Fixed Domes	18
Outdoor Fixed Domes	27
Bullet Cameras	30
Motorized Domes	35



IP RECORDERS	40
Overview IP Recorders	42
IP Recorders	43



HD VIDEO CAMERAS	46
Overview HD Cameras	48
HD Box Cameras	49
Indoor Fixed Domes	50
Outdoor Fixed Domes	52
Bullet Cameras	54



STANDALONE HDVR	56
Overview HDVR Recorders	58
HDVR Recorders	59



ANALOGUE CAMERAS	64
Overview Analogue Cameras	66
Box Cameras	68
Indoor Fixed Domes	72
Outdoor Fixed Domes	77
Bullet Cameras	85
Motorized Domes	89



ANALOGUE RECORDERS	92
Overview DVR Recorders	94
DVR Recorders	95



MONITORS	100
Overview Monitors	102
Monitors	103



TRANSMISSION	110
IP Encoder	112
IP Copper	113
Fiber	115
HD-SDI Copper	116



HOUSINGS & BRACKETS	118
Camera Brackets	120
Dome Housings and Brackets	122



CABLES & ACCESSORIES	124
Cable, Lens	126
Keyboard, Software	127
Remote Controller	128
External Storage	129

TERMS OF DELIVERY	130
--------------------------------	-----

PRODUCT INDEX	131
----------------------------	-----

IP CAMERAS

The IP camera range includes 2MP and 3MP variations of the Grundig compact, indoor and outdoor domes, box cameras, integrated bullet cameras and PTZ speed domes. Specialist features include enhanced low light sensitivity and wide dynamic range (WDR).













GRUNDIG











OVERVIEW IP CAMERAS

BOX CAMERAS



MODEL	PICTURE	IMAGE SENSOR	MINIMUM SENSITIVITY	FOCAL LENGTH	VIEWING ANGLE	LENS DRIVE TYPE	IR LED	WDR MODE	OPERATING TEMPERATURE	POWER SUPPLY	PAGE
GCI-H2505B		1/3" Sony Exmor™ CMOS 1,3 Megapixel	0.005 Lux@F1.2 (IRE50)	-	-	DC auto iris, manual iris	-	130dB (Shutter WDR)	-10°C ~ +50°C	12 VDC / 24 VAC / PoE IEEE 802.3af	8
GCI-K1505B		1/1.9" Sony ExmorRS™ 2 Megapixel	0.0005 Lux @F1.5 (IRE30)	-	-	DC auto iris, manual iris	-	96dB (Shutter WDR)	0°C ~ +50°C	12 VDC / 24 VAC / PoE IEEE 802.3af	9
GCI-K2505B		1/2.8" Sony Exmor™ CMOS 2 Megapixel	0.001 Lux@F1.2 (IRE50)	-	-	DC auto iris, manual iris	-	96dB (Shutter WDR)	-10°C ~ +50°C	12 VDC / 24 VAC / PoE IEEE 802.3af	10
GCI-K3505B		1/2.8" Sony Exmor™ CMOS 2 Megapixel	0.001 Lux @F1.2 (IRE30)	-	-	DC auto iris, manual iris	-	96dB (Shutter WDR)	-10°C ~ +50°C	12 VDC / 24 VAC / PoE IEEE 802.3af	11
GCI-K1603B		1/2.7" CMOS, 2 Megapixel	0.5 Lux@F1.2 (IRE50), 0.2 Lux@F1.2 (IRE30)	-	-	DC auto iris, manual iris	-	D-WDR	-10°C ~ +50°C	12 VDC / PoE IEEE 802.3af	12
GCI-K1503B		1/2.7" CMOS, 2 Megapixel	0.1 Lux@F1.2 (IRE50), 0.02 Lux@F1.2 (IRE30)	-	-	DC auto iris, manual iris	-	D-WDR	-10°C ~ +50°C	12 VDC / 24 VAC / PoE IEEE 802.3af	13
GCI-F0505B		1/2.8" Sony Exmor™ CMOS, 3 Megapixels	0.1 Lux@F1.2 (IRE50), 0.02 Lux@F1.2 (IRE30)	-	-	DC auto iris, manual iris	-	D-WDR	-10°C ~ +50°C	12 VDC / PoE IEEE 802.3af	14
GCI-G0509B		1/2.5" CMOS 5.0 5 Megapixel	0.1 Lux@F1.2 (IRE50), 0.02 Lux@F1.2 (IRE30)	-	-	DC auto iris, manual iris	-	D-WDR	-10°C ~ +50°C	12 VDC / 24 VAC / PoE IEEE 802.3af	15
GCI-N0503B		1/2.3" CMOS 8 Megapixel	0.1 Lux@F1.2 (IRE50), 0.02 Lux@F1.2 (IRE30)	-	-	DC auto iris, manual iris	-	D-WDR	-10°C ~ +50°C	12 VDC / 24 VAC / PoE IEEE 802.3af	16
GCI-K1555Z		1/2.8" Sony CMOS 2 Megapixel	0.02 lux @ F1.6	-	-	DC auto iris	-	D-WDR	0°C ~ +40°C	12 VDC / 24 VAC / PoE IEEE 802.3af	17

INDOOR FIXED DOMES





GCI-H2812W		1/2.7" CMOS, 2 Megapixel	0.6 Lux@F1.8(IRE50), 0.1 Lux@F1.8(IRE30)	3.6 mm	88°	-	-	D-WDR	-10°C ~ +50°C	PoE IEEE 802.3af	18
GCI-K2812W		1/2.7" CMOS, 2 Megapixel	0.6 Lux@F1.8(IRE50), 0.1 Lux@F1.8(IRE30)	3.6 mm	88°	-	-	D-WDR	-10°C ~ +50°C	PoE IEEE 802.3af	19
GCI-F2812W		1/2.8" Sony Exmor™ CMOS, 3 Megapixels	0.6 Lux@F1.8(IRE50), 0.1 Lux@F1.8(IRE30)	3.6 mm	88°	-	-	D-WDR	-10°C ~ +50°C	12 VDC / 24 VAC / PoE IEEE 802.3af	20
GCI-K0622D		1/2.7" CMOS, 2 Megapixel	0.1 Lux@F1.2 (IRE50), 0.02 Lux@F1.2 (IRE30)	3 ~ 10.5 mm	approx. 90°(w) ~ 33° (t)	DC auto iris	-	D-WDR	-10°C ~ +50°C	12 VDC / 24 VAC / PoE IEEE 802.3af	21
GCI-K1627D		1/2.8" Sony Exmor™ CMOS 2 Megapixel	0.001 Lux@F1.4 (IRE30), 0.01 Lux@F1.4 (IRE50)	3 ~ 10.5 mm	approx. 93°(w) ~ 32° (t)	DC auto iris	21 pcs., 90° beam- ing angle	96dB (Shutter WDR)	-10°C ~ +50°C	12 VDC / 24 VAC / PoE IEEE 802.3af	22
GCI-K1677D		1/2.8" Sony Exmor™ CMOS 2 Megapixel	0.001 Lux@F1.4 (IRE30), 0.01 Lux@F1.4 (IRE50)	3 ~ 9 mm	approx. 93°(w) ~ 32° (t)	Tamron@ AFZ, P-Iris	21 pcs., 90° beam- ing angle	96dB (Shutter WDR)	-10°C ~ +50°C	112 VDC / 24 VAC / PoE IEEE 802.3af	23
GCI-F0676D		1/2.8" Sony Exmor™ CMOS, 3 Megapixels	0.1 Lux@F1.2 (IRE50), 0.02 Lux@F1.2 (IRE30)	3 ~ 9 mm	approx. 104°(H) ~ 33°(V)	Tamron@ AFZ, P-Iris	24 pcs., 90° beam- ing angle	D-WDR	-10°C ~ +50°C	12 VDC / 24 VAC / PoE IEEE 802.3af	24
GCI-G1536F		1/2.5" CMOS, 5 Megapixel	0.02 Lux@F2.8	1.05 mm	180° circle (full hemi- sphere)	DC auto iris	6 pieces	D-WDR	-10°C ~ +50°C	12 VDC / 24 VAC / PoE IEEE 802.3af	25

MODEL	PICTURE	IMAGE SENSOR	MINIMUM SENSITIVITY	FOCAL LENGTH	VIEWING ANGLE	LENS DRIVE TYPE	IR LED	WDR MODE	OPERATING TEMPERATURE	POWER SUPPLY	PAGE
GCI-M0566F		1/1.8" Sony Exmor™ CMOS 6 Megapixel	0.2 Lux@F2.8	1.05 mm	180° @ Full Resolution	Fixed iris	6 pieces	D-WDR	-10°C ~ +50°C	12 VDC / 24 VAC / PoE IEEE 802.3af	26

OUTDOOR FIXED DOMES

GCI-K1527V		1/2.8" Sony Exmor™ CMOS 2 Megapixel	0.001 Lux@F1.4 (IRE30), 0.01 Lux@F1.4 (IRE50)	3 ~ 10.5 mm	approx. 93°(w) ~ 32° (t)	Auto iris (DC)	24 pcs.	96dB (Shutter WDR)	-25°C ~ +55°C	12 VDC / 24 VAC / PoE IEEE 802.3af	27
GCI-K1587V		1/2.8" Sony Exmor™ CMOS 2 Megapixel	0.001 Lux@F1.4 (IRE30), 0.01 Lux@F1.4 (IRE50)	3 ~ 9 mm	approx. 93°(w) ~ 32° (t)	Tamron® AFZ Module, P-Iris	24 pcs.	96dB (Shutter WDR)	-25°C ~ +55°C	12 VDC / 24 VAC / PoE IEEE 802.3af	28
GCI-F1576VH		1/2.8" Sony Exmor™ CMOS, 3 Megapixel	0.1 Lux@F1.2 (IRE50), 0.02 Lux@F1.2 (IRE30)	3 ~ 9 mm	approx. 104°(H) ~ 33°(V)	Tamron® AFZ Module, P-Iris	24 pcs., 90° beaming angle	75dB (D-WDR) Off/Low/Middle/High	-40°C ~ +55°C	12 VDC / 24 VAC / PoE IEEE 802.3at	29

BULLET

GCI-K1526T		1/2.7" CMOS, 2 Megapixel	0.1 Lux@F1.4 (IRE50), 0.02 Lux@F1.4 (IRE30)	3 ~ 9 mm	approx. 104°(H) ~ 33°(V)	Auto iris (DC)	23 pcs., 90° beam. angle	D-WDR	-25°C ~ +55°C	12 VDC / 24 VAC / PoE IEEE 802.3af	30
GCI-K1526TH		1/2.7" CMOS, 2 Megapixel	0.1 Lux@F1.4 (IRE50), 0.02 Lux@F1.4 (IRE30)	3 ~ 9 mm	approx. 104°(H) ~ 33°(V)	Auto iris (DC)	23 pcs., 90° beam. angle	D-WDR	-35°C ~ +55°C	12 VDC / 24 VAC / PoE IEEE 802.3af (without heater)	31
GCI-K0589T-1		1/2.7" CMOS, 2 Megapixel	0.1 Lux@F1.2 (IRE50), 0.02 Lux@F1.2 (IRE30)	3 ~ 9 mm	108°(W) ~ 41°(T)	Tamron® AFZ Module, P-Iris	23 pcs., 90° beam. angle	D-WDR	-25°C ~ +55°C	12 VDC / 24 VAC / PoE IEEE 802.3af	32
GCI-F0576TH		1/2.8" Sony Exmor™ CMOS, 3 Megapixels	0.02 lux @ F1.2	3 ~ 9 mm	approx. 100°(w) ~ 35°(t)	Tamron® AFZ Module, P-Iris	24 pcs., 90° beam. Angle	75dB (D-WDR)	-40°C ~ +55°C	24VAC/ PoE IEEE802.3at	33
GCI-K1577TH		1/1.9" Sony ExmorRS™ CMOS 2 Megapixel	0.0005 Lux@F1.5 (IRE30), 0.005 Lux@F1.5 (IRE50)	3.3 ~ 8 mm	approx. 104°(W) ~ 33°(T)	Motorized Zoom & Focus	24 pcs.	96dB (Shutter WDR)	-40°C ~ +50°C	24VAC/ PoE IEEE802.3at	34

MOTORISED DOMES

GCI-C0745P-1		1/4" CCD (Super HAD II) 0.5 Megapixel	0.1 lux (Colour) / 0.01 lux [B&W]	3.4 ~ 122.4 mm	60.08° ~ 1.8°	Auto iris (DC)	-	Shutter WDR	-40°C ~ +50°C	24 VAC/VDC ±10%	35
GCI-K0779P		1/2.8" Sony Exmor™ CMOS 2 Megapixel	0.001 Lux@F1.6 (IRE50)	4.7 ~ 84.6 mm	55.2° (Wide) ~ 3.2° (Tele)	Auto iris (DC)	-	D-WDR	0°C ~ +40°C	24 VAC / h PoE	36
GCI-K1779P		1/2.8" Sony Exmor™ CMOS 2 Megapixel	0.001 Lux@F1.6 (IRE50)	4.7 ~ 84.6 mm	55.2° (Wide) ~ 3.2°(Tele)	Auto iris (DC)	-	D-WDR	-40°C ~ +60°C	24 VAC / hPoE (Heater only 24VAC)	37
GCI-K2795P		1/2.8" Sony Exmor™ CMOS 2 Megapixel	0.095 lux @ F1.6 (IRE50)	4.3 ~ 129 mm	65.5° (Tele) / 3.18° (Wide)	Auto iris (DC)	-	D-WDR	-40°C ~ +50°C	24VAC/ PoE(IEEE 802.3at 60W)	38



GCI-H2505B

1.3 MP HD Box IP-Camera ICR WDR Low Light

- 1.3 Megapixel Day/Night camera
- WDR (Wide Dynamic Range) for extreme backlight applications
- 3DNR super noise reduction for efficient recording
- ONVIF Profile S
- SDHC memory card slot for alarm and scheduled image recording
- Bidirectional audio support
- Power input AC24V/DC12V and PoE

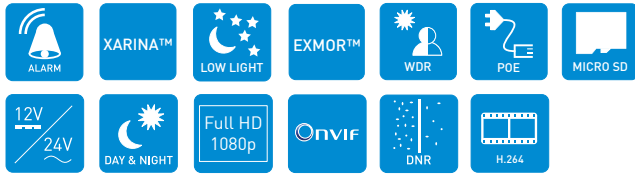

DIMENSIONS (MM)

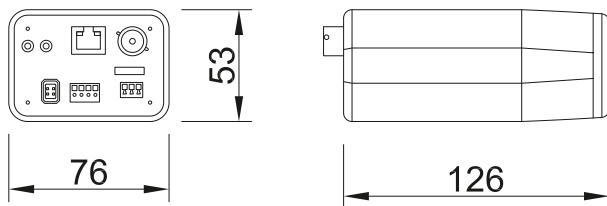

ACCESSORIES

GBR-WA03



SPECIFICATIONS

Image Sensor:	1/3" Sony Exmor™ CMOS 1.3 Megapixel
Pixels - Total:	1280(H) x 960(V)
Digital Signal Processor (DSP):	Sony Xarina Solution
Col/B&W:	On/Off/Auto, IR-cut filter removable (ICR)
Sensitivity Colour:	0.03 Lux @ F1.2
Sensitivity B&W:	0.005 Lux@F1.2 (IRE50)
Lens Mount:	C/CS mount
Lens Drive Type:	DC auto iris, manual iris
Shutter Speed:	1 ~ 1/10.000 sec
BLC: Backlight:	On/Off
WDR:	130dB (Shutter WDR)
Digital Noise Reduction (DNR):	On/off 2D/3D Noise Filter
White Balance:	ATW, AWB, Manual
Motion Detection:	On/ Off/ Sensitivity/ Area setting
Privacy Zones:	5 zones, rectangle
Tampering Alarm:	On/Off
Camera ID:	20 character
Alarm I/O:	1 (5V, 10KΩ) / 1 (max.300VDC/AC, 39W)
Digital Zoom:	Yes
Web Browser:	MS Internet Explorer 6.0 (or higher), Firefox, Google Chrome, Safari
Number of Clients:	Up to 20 simultaneously
Video Compression:	H.264 (MPEG-Part10/AVC), MJPEG
Video Resolution:	1280x1024, 1280x720, 1024x768, 800x600, 720x576, 640x480, 352x288, 176x144
Video Streaming:	Single Stream, Dual Stream, Triple Stream, Quad stream
Network Protocol:	IPv4, IPv6, TCP/IP, UDP, RTP, RTSP, HTTP, HTTPS, ICMP, FTP, SMTP, DHCP, PPPoE, UPnP, IGMP, 802.1X and SNMP
SD Memory:	supports up to 64GB capacity of micro SD/SDHC memory on Micro SD/SDHC CARD, Single Image Recording (JPEG)
Recording Types:	Video(AVI)
Alarm Event:	Image transfer or alarm message by FTP, Image transfer or alarm message by E-mail, recording on SD-card, enabling alarm output
Audio Compression:	G.726, G.711
LED Indicator:	Power, link, active
Video Outputs:	1Vpp, BNC
Input/Output Sockets:	Video Out(BNC), Power(3-Pin Term), RJ-45, Micro SD Card Slot, Terminal 7- Pin (Alarm In 2-Pin, Alarm Out 2-Pin, RS485 2-Pin), Audio (2 mini Jack 3.5mm), Auto-Iris (4Pin)
Interfaces:	RS-485
Protocol:	Pelco D, Pelco P
PTZ Control:	Pan/Tilt/Zoom/Focus/Preset/Sequence, Pelco D/P
Operating Temperature:	-10°C ~ +50°C
Humidity:	10 ~ 90% no condensation
Standards:	CE, FCC, RoHS Compliant
Supply Voltage:	12 VDC / 24 VAC / PoE IEEE 802.3af
Power Consumption:	6 W
Weight:	0.36 kg
Dimensions (WxHxD):	76 x 53 x 126 mm



GCI-K1505B

2 MP Full HD Box-IP-Kamera ICR WDR Ultra Low light

- 2 Megapixel IP camera with Full - HD 1080P real time video streaming
- Ultra low light camera for reduced image noise
- EXMOR™ sensor for low light sensitivity
- XARINA™ DSP for advanced functionality
- WDR (Wide Dynamic Range) for extreme backlight applications
- Day/Night camera with removable IR cut filter with high sensitivity and vibrant colors
- ONVIF Profile S
- SDHC memory card slot for alarm and scheduled image recording
- Power input AC24V/DC12V and PoE

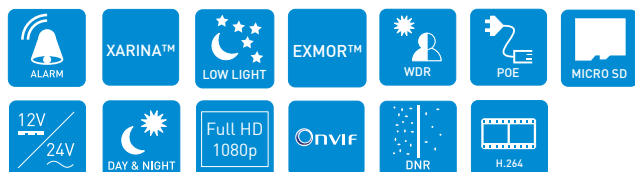

DIMENSIONS (MM)

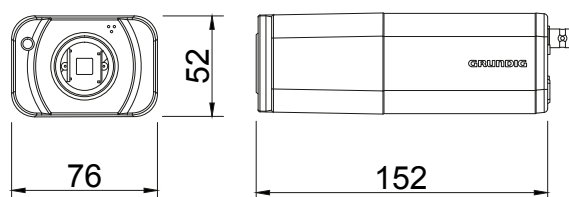

ACCESSORIES

GBR-WA03



SPECIFICATIONS

Image Sensor:	1/1,9" ExmorRSTM Sensor
Pixels - Total:	1920(H) x 1080(V)
Digital Signal Processor (DSP):	Sony Xarina Solution
Col/B&W:	On/Off/Auto, IR-cut filter removable (ICR)
Sensitivity Colour:	0.01 lux @ F1.5 (IRE30)
Sensitivity B&W:	0.0005 lux @ F1.5 (IRE30)
Lens Drive Type:	DC auto iris, manual iris
WDR:	96dB (Shutter WDR)
BLC: Back Light:	On/Off
Digital Noise Reduction (DNR):	On/off 2D/3D Noise Filter
Motion Detection:	On/ Off/ Sensitivity/ Area setting
Tampering Alarm:	On/Off
Privacy Zones:	5 zones, rectangle
White Balance:	ATW, AWB, Manual
Digital Zoom:	Yes
Shutter Speed:	1 ~ 1/10.000 sec
Alarm I/O:	1 (5V, 10KΩ) / 1 (max.300VDC/AC, 39W)
Web Browser:	MS Internet Explorer 6.0 (or higher), Firefox, Google Chrome, Safari
Number of Clients:	Up to 20 simultaneously
Video Compression:	H.264 (MPEG4 Part 10/AVC), MJPEG
Video Resolution:	Full HD 1080p/ SXGA/ HD 720p/ XGA/SVGA/ 4CIF/ VGA/ CIF
Video Streaming:	Single Stream, Dual Stream, Triple Stream, Quad stream
Network Protocol:	IPv4/v6, TCP/IP, UDP, RTP, RTSP, HTTP, HTTPS, DHCP, PPPoE, UPnP, SMTP, ICMP, IGMP, SNMP, IEEE802.1x, QoS, ONVIF, ARP
SD Memory:	supports up to 64GB capacity of micro SD/SDHC memory
Alarm Event:	Image Transfer or Alarm Message by FTP, Image Transfer or Alarm Message by E-mail, Recording on SD-Card, enable Alarm Output and send HTTP Notification
Audio Compression:	G.726, G.711
LED Indicator:	Power, link, active
Video Outputs:	1Vpp, BNC
Input/Output Sockets:	Video Out(BNC), Power(3-Pin Term), RJ-45, Micro SD Card Slot, Terminal 7-Pin (Alarm In 2-Pin, Alarm Out 2-Pin, RS485 2-Pin), Audio (2 mini Jack 3.5mm), Auto-Iris (4Pin)
Operating Temperature:	0°C ~ +50°C
Humidity:	10 ~ 90% no condensation
Standards:	CE, FCC, RoHS Compliant
Supply Voltage:	12 VDC / 24 VAC / PoE IEEE 802.3af
Power Consumption:	4 W
Weight:	0.36 kg
Dimensions (WxHxD):	76 x 52 x 152 mm

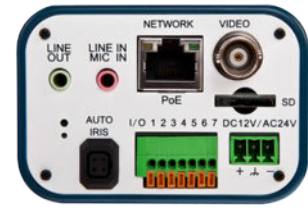

GCI-K2505B

2 MP Full HD Box IP-Camera ICR WDR

- 2 Megapixel IP camera with Full - HD, 1080P, real time video streaming
- High frame rate - 60 frames per second at Full HD resolution
- WDR (Wide Dynamic Range) for extreme backlight applications
- 3DNR super noise reduction for efficient recording
- ONVIF Profile S
- SDHC memory card slot for alarm and scheduled image recording
- Bidirectional audio support
- Power input AC24V/DC12V and PoE

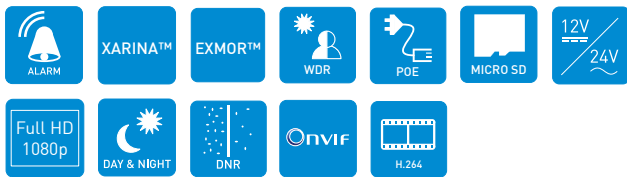

DIMENSIONS (MM)

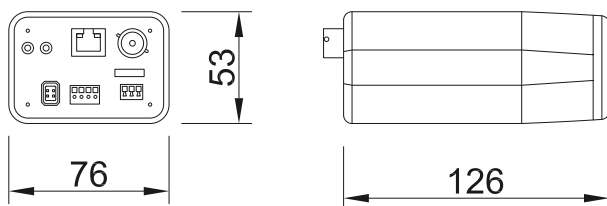

ACCESSORIES

GBR-WA03



SPECIFICATIONS

Image Sensor:	1/2.8" Sony Exmor™ CMOS
Pixels - Total:	1920(H) x 1080(V)
Digital Signal Processor (DSP):	Sony Xarina Solution
Col/B&W:	On/Off/Auto, IR-cut filter removable (ICR)
Sensitivity Colour:	0.01 Lux @ F1.2 (IRE30)
Sensitivity B&W:	0.001 Lux@F1.2 (IRE30)
Lens Mount:	C/CS mount
Lens Drive Type:	DC auto iris, manual iris
Shutter Speed:	1 ~ 1/10.000 sec
BLC: Back Light:	On/Off
WDR:	96dB (Shutter WDR)
Digital Noise Reduction (DNR):	On/off 2D/3D Noise Filter
White Balance:	ATW, AWB, Manual
Motion Detection:	On/ Off/ Sensitivity/ Area setting
Privacy Zones:	5 zones, rectangle
Tampering Alarm:	On/Off
Camera ID:	20 character
Digital Zoom:	Yes
Alarm I/O:	1 (5V, 10KΩ) / 1 (max.300VDC/AC, 39W)
Web Browser:	MS Internet Explorer 6.0 (or higher), Firefox, Google Chrome, Safari
Number of Clients:	Up to 20 simultaneously
Video Compression:	H.264 (MPEG4 Part10/AVC), MJPEG
Video Resolution:	Full HD 1080p / SXGA / HD720p / XGA / SVGA / 4CIF / VGA / CIF
Video Streaming:	Single Stream, Dual Stream, Triple Stream, Quad stream
LED Indicator:	Power, link, active
Network Protocol:	IPv4/v6, TCP/IP, UDP, RTP, RTSP, HTTP, HTTPS, DHCP, PPPoE, UPnP, SMTP, ICMP, IGMP, SNMP, IEEE802.1x, QoS, ONVIF, FTP
SD Memory:	supports up to 64GB capacity of micro SD/SDHC memory
Recording Types:	on Micro SD/SDHC CARD Single Image Recording (JPEG) Video (AVI)
Alarm Event:	Image transfer or alarm message by FTP, Image transfer or alarm message by E-mail, recording on SD-card and enable alarm output
Audio Compression:	G.726, G.711
Video Outputs:	1Vpp, BNC
Input/Output Sockets:	Video Out(BNC), Power(3-Pin Term), RJ-45, Micro SD Card Slot, Terminal 7-Pin (Alarm In 2-Pin, Alarm Out 2-Pin, RS485 2-Pin), Audio (2 mini Jack 3.5mm), Auto-Iris (4Pin)
Interfaces:	RS-485
Protocol:	Pelco D, Pelco P
PTZ Control:	Pan/Tilt/Zoom/Focus/Preset/Sequence, Pelco D/P
Operating Temperature:	-10°C ~ +50°C
Humidity:	10 ~ 90% no condensation
Standards:	CE, FCC, RoHS Compliant
Supply Voltage:	12 VDC / 24 VAC / PoE IEEE 802.3af
Power Consumption:	4 W
Weight:	0.36 kg
Dimensions (WxHxD):	76 x 53 x 126 mm



GCI-K3505B

2 MP Full HD Box IP-Camera ICR WDR

Auto-Back-Focus

- 2 Megapixel IP camera with Full - HD, 1080P, real time video streaming
- High frame rate - 60 frames per second at Full HD resolution
- Automatic Back-Focus adjustment for simplified lens setup
- WDR (Wide Dynamic Range) for extreme backlight applications
- 3DNR super noise reduction for efficient recording
- ONVIF Profile S
- SDHC memory card slot for alarm and scheduled image recording
- Bidirectional audio support
- Power input AC24V/DC12V and PoE



DIMENSIONS (MM)

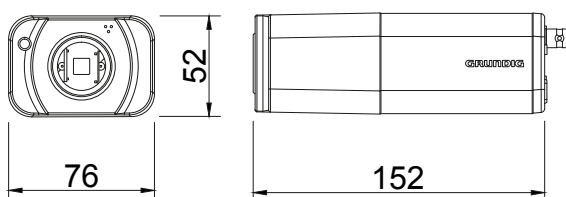

ACCESSORIES

GBR-WA03



SPECIFICATIONS

Image Sensor:	1/2.8" Sony Exmor™ CMOS
Pixels - Total:	1920(H) x 1080(V)
Digital Signal Processor (DSP):	Sony Xarina Solution
Sensitivity Colour:	0.01 lux @ F1.2 (IRE30)
Sensitivity B&W:	0.001 lux @ F1.2 (IRE30)
CoI/B&W:	On/Off/Auto, IR-cut filter removable (ICR)
Lens Mount:	C/CS mount
Lens Drive Type:	DC auto iris, manual iris
Focus Adjustment:	Auto back focus
Digital Zoom:	Off/2 ~ 16x
Shutter Speed:	1 ~ 1/10.000 sec
AGC:	Off, 3~72dB
BLC: Backlight:	On/Off
WDR:	96dB [Shutter WDR]
White Balance:	ATW, AWB, Manual
Privacy Zones:	5 zones, rectangle
Motion Detection:	On/ Off/ Sensitivity/ Area setting
Digital Image Stabilization (DIS):	Off/On
Tampering Alarm:	On/Off
Reverse:	Flip, Mirror, 180°
Digital Noise Reduction (DNR):	On/off 2D/3D Noise Filter
Camera ID/OSD:	20 character/ Yes, multi language
Alarm Event:	Image transfer or alarm message by FTP, Image transfer or alarm message by E-mail, recording on SD-card and enable alarm output
Alarm I/O:	1 (5V, 10KΩ) / 1 (max.300VDC/AC, 39W)
SD Memory:	supports up to 64GB capacity of micro SD/SDHC memory
Recording Types:	on Micro SD/SDHC CARD Single Image Recording (JPEG) Video(AVI)
LED Indicator:	Power, link, active
Input/Output Sockets:	Video Out(BNC), Power(3-Pin Term), RJ-45, Micro SD Card Slot, Terminal 7-Pin (Alarm In 2-Pin, Alarm Out 2-Pin, RS485 2-Pin), Audio [2 mini Jack 3.5mm), Auto-Iris [4Pin]
Network Interface:	1x RJ-45 10/100Mbps
Video Outputs:	1Vpp, BNC
Interfaces/Protocols:	RS-485/ Pelco-D, Pelco P
Web Browser:	MS Internet Explorer 6.0 (or higher), Firefox, Google Chrome, Safari
Access protection:	By log-in and Password, IP filter, IEEE802.1x
Number of Clients:	Up to 20 simultaneously
Video Compression:	H.264 (MPEG-4Part 10/AVC), MJPEG
Video Streaming:	Single-, Dual, Triple-, Quad Stream
Video Resolution:	Full HD 1080p /SXGA / HD720p / XGA / SVGA / 4CIF/ VGA / CIF
Network Protocol:	IPv4/v6, TCP/IP, UDP, RTP, RTSP, HTTP, HTTPS, DHCP, PPPoE, UPnP, SMTP, ICMP, IGMP, SNMP, IEEE802.1x, QoS, ONVIF, FTP
Audio:	G.726, G.711, Bi-directional
ONVIF compliant:	Profile S
Operating Temperature:	-10°C ~ +50°C
Humidity:	10 ~ 90% no condensation
Standards:	CE, FCC, RoHS Compliant
Supply Voltage:	12 VDC / 24 VAC / PoE IEEE 802.3af
Power Consumption:	9.5 W
Weight:	0.4 kg
Dimensions (WxHxD):	76 x 52 x 152 mm

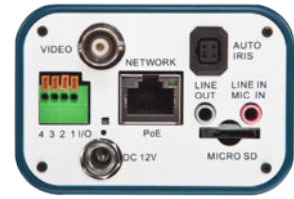

GCI-K1603B

2 MP HD Box IP-Camera Soft D/N dWDR

- 2 Megapixel colour IP camera, with real time HD 720P and 1080P video streams at 13FPS
- ONVIF Profile S
- SDHC memory card slot for alarm and scheduled image recording
- Bidirectional audio support
- Power input DC12V and PoE



SPECIFICATIONS

Image Sensor:	1/2.7" CMOS, 2 Megapixel
Pixels - Total:	1920(H) x 1080(V)
Digital Signal Processor (DSP):	Ambarella A55
Col/B&W:	Auto [Electronic] / Color / B/W
Sensitivity Colour:	0.5 Lux@F1.2 (IRE50), 0.2 Lux@F1.2 (IRE30)
Lens Mount:	C/CS mount with adaptor
Lens Drive Type:	DC auto iris, manual iris
Shutter Speed:	1 ~ 1/10.000 sec
BLC: Back Light:	On/Off
WDR:	D-WDR (Digital wide dynamic range)
Digital Noise Reduction (DNR):	On/off 2D/3D Noise Filter
Motion Detection:	On/ Off/ Sensitivity/ Area setting
Tampering Alarm:	On/Off
Privacy Zones:	5 zones, rectangle
White Balance:	ATW, AWB, Manual
Digital Zoom:	Yes
Camera ID:	20 character
Alarm I/O:	1 [5V, 10KΩ] / 1 (max.300VDC/AC, 39W)
Web Browser:	MS Internet Explorer 6.0 [or higher], Firefox, Google Chrome, Safari
Number of Clients:	Up to 20 simultaneously
Video Compression:	H.264 (MPEG4 Part10/AVC), MJPEG
Video Resolution:	Full HD 1080p / SXGA / HD720p / XGA / SVGA / 4CIF / VGA / CIF
Video Streaming:	Single Stream, Dual Stream, Triple Stream, Quad stream IPv4/v6, TCP/IP, UDP, RTP, RTSP, HTTP, HTTPS, DHCP,
Network Protocol:	PPPoE, UPnP, SMTP, ICMP, IGMP, SNMP, IEEE802.1x, QoS, ONVIF, FTP
SD Memory:	supports up to 32 GB capacity of micro SD/SDHC memory on Micro SD/SDHC CARD:
Recording Types:	Single Image Recording (JPEG), Video(AVI, LCK) on NAS: Video (AVI)
Alarm Event:	Image transfer or alarm message by FTP, Image transfer or alarm message by E-mail, recording on SD-card and enable alarm output
Audio Compression:	G.726, G.711
LED Indicator:	Power, link, active
Video Outputs:	1Vpp, BNC
Input/Output Sockets:	Video OUT(BNC), Power(DC Jack), RJ-45, Micro SD Card Slot, Alarm, Terminal 4-Pin (Alarm In 2-Pin, Alarm Out 2-Pin), Audio [2 mini Jack 3.5mm]
Operating Temperature:	-10°C ~ +50°C
Humidity:	10 ~ 90% no condensation
Standards:	CE, FCC, RoHS Compliant
Supply Voltage:	12 VDC / PoE IEEE 802.3af
Power Consumption:	4 W
Weight:	0.36 kg
Dimensions (WxHxD):	76 x 53 x 126 mm

DIMENSIONS (MM)

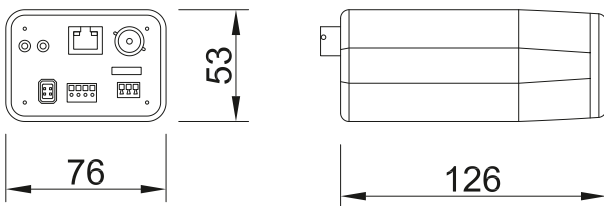

ACCESSORIES

GBR-WA03





GCI-K1503B

2 MP Full HD Box IP-Camera ICR dWDR

- 2 Megapixel IP camera with Full-HD, 1080p, real time video streaming
- 3DNR super-noise reduction for efficient recording
- ONVIF Profile S
- SDHC memory card slot for alarm and scheduled image recording
- Bidirectional audio support
- Power input AC24V/DC12V and PoE

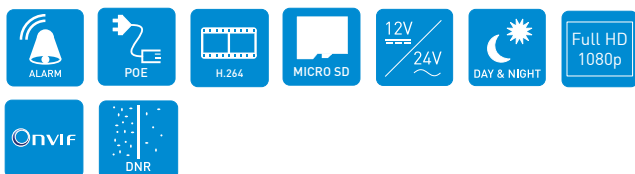

DIMENSIONS (MM)

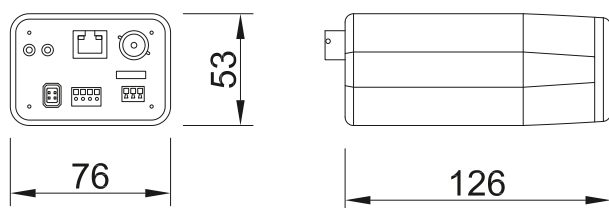

ACCESSORIES

GBR-WA03



SPECIFICATIONS

Image Sensor:	1/2.7" CMOS, 2 Megapixel
Pixels - Total:	1920(H) x 1080(V)
Digital Signal Processor (DSP):	Ambarella A55
Col/B&W:	On/Off/Auto, IR-cut filter removable (ICR)
Sensitivity Colour:	0.5 Lux@F1.2 (IRE50), 0.2 Lux@F1.2 (IRE30)
Sensitivity B&W:	0.1 Lux@F1.2 (IRE50), 0.02 Lux@ F1.2 (IRE30)
Lens Mount:	C/CS mount with adaptor
Lens Drive Type:	Auto iris (DC)
Shutter Speed:	1 ~ 1/10.000 sec
WDR:	D-WDR (Digital wide dynamic range)
BLC: Back Light:	On/Off
Digital Noise Reduction (DNR):	On/off 2D/3D Noise Filter
Motion Detection:	On/ Off/ Sensitivity/ Area setting
Tampering Alarm:	On/Off
Privacy Zones:	5 zones, rectangle
White Balance:	ATW, AWB, Manual
Digital Zoom:	Yes
Camera ID:	20 character
Alarm I/O:	1 (5V, 10KΩ) / 1 (max.300VDC/AC, 39W)
Web Browser:	MS Internet Explorer 6.0 (or higher), Firefox, Google Chrome, Safari
Number of Clients:	Up to 20 simultaneously
Video Compression:	H.264 (MPEG4 Part10/AVC), MJPEG
Video Resolution:	Full HD 1080p /SXGA / HD720p / XGA / SVGA / 4CIF/ VGA / CIF
Video Streaming:	Single Stream, Dual Stream, Triple Stream, Quad stream
Network Protocol:	IPv4/v6, TCP/IP, UDP, RTP, RTSP, HTTP, HTTPS, DHCP, PPPoE, UPnP, SMTP, ICMP, IGMP, SNMP, IEEE802.1x, QoS, ONVIF, FTP
SD Memory:	supports up to 32 GB capacity of micro SD/SDHC memory
Recording Types:	on Micro SD/SDHC CARD., Single Image Recording (JPEG), Video(AVI, LCK) , on NAS: Video (AVI)
Alarm Event:	Image transfer or alarm message by FTP, Image transfer or alarm message by E-mail, recording on , SD-card and enable alarm output
Audio Compression:	G.726, G.711
LED Indicator:	Power, link, active
Video Outputs:	1Vpp, BNC
Input/Output Sockets:	Video Out(BNC), Power(3-Pin Term), RJ-45, Micro SD Card Slot, Terminal 7-Pin (Alarm In 2-Pin, Alarm Out 2-Pin, RS485 2-Pin), Audio (2 mini , Jack 3.5mm), Auto-Iris (4Pin)
Interfaces:	RS-485
Protocol:	Pelco D, Pelco P
PTZ Control:	Pan/Tilt/Zoom/Focus/Preset/Sequence, Pelco D/P
Operating Temperature:	-10°C ~ +50°C
Humidity:	10 ~ 90% no condensation
Standards:	CE, FCC, RoHS Compliant
Supply Voltage:	12 VDC / 24 VAC / PoE IEEE 802.3af
Power Consumption:	4 W
Weight:	0.36 kg
Dimensions (WxHxD):	76 x 53 x 126 mm



GCI-F0505B

3 MP Full HD Box IP-Camera ICR dWDR

- Day/Night feature with removable IR cut filter for higher sensitivity and vibrant colors
- H.264 & MJPEG compression modes (max. 25 fps)
- ONVIF Profile S
- SDHC memory card slot for alarm and scheduled image recording
- Bidirectional audio support

SPECIFICATIONS

DC auto iris, manual iris	1/2.8" Sony Exmor™ CMOS, 3 Megapixels
Pixels - Total:	2048 (H) x 1536 (V)
Digital Signal Processor (DSP):	Ambarella A55
Col/B&W:	On/Off/Auto, IR-cut filter removable (ICR)
Sensitivity Colour:	0.5 Lux@F1.2 (IRE50), 0.2 Lux@F1.2 (IRE30)
Sensitivity B&W:	0.1 Lux@F1.2 (IRE50), 0.02 Lux@ F1.2 (IRE30)
Lens Mount:	C/CS mount
Lens Drive Type:	Auto iris (DC)
Shutter Speed:	1 ~ 1/10.000 sec
WDR:	75dB (Digital Wide Dynamic Range) Off/Low/Middle/High
BLC: Backlight:	On/Off
Digital Noise Reduction (DNR):	On/off 2D/3D Noise Filter
Motion Detection:	On/ Off/ Sensitivity/ Area setting
Tampering Alarm:	On/Off
Privacy Zones:	5 zones, rectangle
White Balance:	ATW, AWB, Manual
Digital Zoom:	Yes
Camera ID:	20 character
Alarm I/O:	1 (5V, 10KΩ) / 1 (max.300VDC/AC, 39W)
Web Browser:	MS Internet Explorer 6.0 (or higher), Firefox, Google Chrome, Safari
Number of Clients:	Up to 20 simultaneously
Video Compression:	H.264 (MPEG4 Part10/AVC), MJPEG
Video Resolution:	3MP (2048x1536) / Full HD 1080p /SXGA / HD720p / XGA / SVGA / 4CIF/ VGA / CIF.
Video Streaming:	Single Stream, Dual Stream, Triple Stream, Quad stream
Network Protocol:	IPv4/v6, TCP/IP, UDP, RTP, RTSP, HTTP, HTTPS, DHCP, PPPoE, UPnP,SMTP, ICMP, IGMP, SNMP, IEEE802.1x, QoS, ONVIF, FTP
SD Memory:	supports up to 32 GB capacity of micro SD/SDHC memory
Recording Types:	on Micro SD/SDHC CARD: Single Image Recording (JPEG), Video(AVI, LCK) on NAS: Video (AVI)
Alarm Event:	Image transfer or alarm message by FTP, Image transfer or alarm message by E-mail, recording on SD-card and enable alarm output
Audio Compression:	G.726, G.711
LED Indicator:	Power, link, active
Video Outputs:	1Vpp, BNC
Input/Output Sockets:	Video OUT(BNC), Power(DC Jack), RJ-45, Micro SD Card Slot, Alarm Terminal 4-Pin(Alarm In 2-Pin, Alarm Out 2-Pin), Audio (2 mini Jack 3.5mm)
Operating Temperature:	-10°C ~ +50°C
Humidity:	10 - 90% no condensation
Standards:	CE, FCC, RoHS Compliant
Supply Voltage:	12 VDC / PoE IEEE 802.3af
Power Consumption:	4 W
Weight:	0.36 kg
Dimensions (WxHxD):	Dimensions (WxHxD): 76 x 53 x 126



DIMENSIONS (MM)

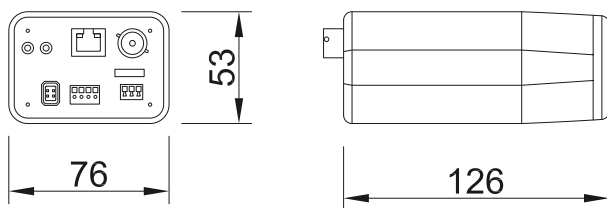

ACCESSORIES

GBR-WA03





GCI-G0509B

5 MP Full HD Box IP-Camera ICR dWDR

- 5 Megapixel IP camera with Full HD 1080p, real time video streaming
- Day/Night feature with removable IR cut filter for higher sensitivity and vibrant colors
- ONVIF Profile S
- SDHC memory card slot for alarm and schedule image recording
- Bidirectional Audio Support
- Power input AC24V/DC12V and PoE

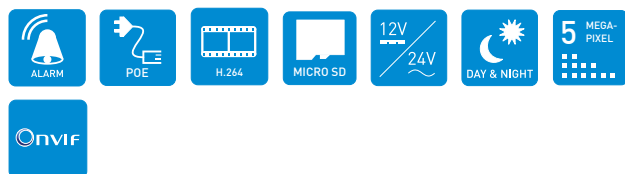

DIMENSIONS (MM)

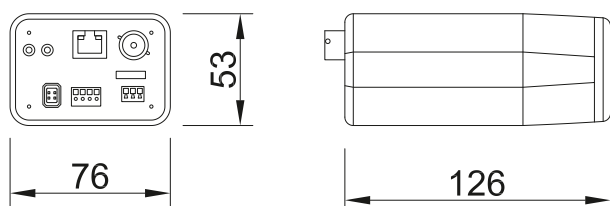

ACCESSORIES

GBR-WA03



SPECIFICATIONS

Image Sensor:	1/2.5" CMOS 5.0 Megapixel
Pixels - Total:	2592 (H) x 1944 (V)
Digital Signal Processor (DSP):	Ambarella A55
Col/B&W:	On/Off/Auto, IR-cut filter removable (ICR)
Sensitivity Colour:	0.5 Lux@F1.2 (IRE50), 0.2 Lux@F1.2 (IRE30)
Sensitivity B&W:	0.1 Lux@F1.2 (IRE50), 0.02 Lux@ F1.2 (IRE30)
Lens Mount:	C/CS mount
Lens Drive Type:	DC auto iris, manual iris
Shutter Speed:	1 ~ 1/10.000 sec
BLC: Back Light:	On/Off
WDR:	D-WDR (Digital wide dynamic range)
Digital Noise Reduction (DNR):	On/off 2D/3D Noise Filter
Motion Detection:	On/ Off/ Sensitivity/ Area setting
Tampering Alarm:	On/Off
Privacy Zones:	5 zones, rectangle
White Balance:	ATW, AWB, Manual
Digital Zoom:	Yes
Camera ID:	20 character
Alarm I/O:	1 (5V, 10KΩ) / 1 (max.300VDC/AC, 39W)
Web Browser:	MS IE 6.0 (or higher), Firefox, Google Chrome, Safari
Number of Clients:	Up to 20 simultaneously
Video Compression:	H.264 (MPEG4 Part10/AVC), MJPEG
Video Resolution:	SMP (2592x1944) / 3MP (2048x1536) / Full HD 1080p /SXGA / HD720p / XGA / SVGA / 4CIF/ VGA / CIF.
Video Streaming:	Single Stream, Dual Stream, Triple Stream, Quad stream
Network Protocol:	IPv4/v6, TCP/IP, UDP, RTP, RTSP, HTTP, HTTPS, DHCP, PPPoE, UPnP, SMTP, ICMP, IGMP, SNMP, IEEE802.1x, QoS, ONVIF, FTP
SD Memory:	supports up to 32 GB capacity of micro SD/SDHC memory
Recording Types:	on Micro SD/SDHC CARD: Single Image Recording (JPEG), Video(AVI, LCK) on NAS: Video (AVI)
Alarm Event:	Image transfer or alarm message by FTP, Image transfer or alarm message by E-mail, recording on SD-card and enable alarm output
Audio Compression:	G.726, G.711
LED Indicator:	Power, link, active
Video Outputs:	1Vpp, BNC
Input/Output Sockets:	Video Out(BNC), Power(3-Pin Term), RJ-45, Micro SD Card Slot, Terminal 7-Pin (Alarm In 2-Pin, Alarm Out 2-Pin, RS485 2-Pin), Audio (2 mini Jack 3.5mm), Auto-Iris (4Pin)
Interfaces/Protocol:	RS-485/ Pelco D, Pelco P
PTZ Control:	Pan/Tilt/Zoom/Focus/Preset/Sequence, Pelco D/P
Operating Temperature:	-10°C ~ +50°C
Humidity:	10 ~ 90% no condensation
Standards:	CE, FCC, RoHS Compliant
Supply Voltage:	12 VDC / 24 VAC / PoE IEEE 802.3af
Power Consumption:	4 W
Weight:	0.36 kg
Dimensions (WxHxD):	76 x 53 x 126 mm



GCI-N0503B

8 MP Ultra HD Box IP-Camera ICR Auto-Back-Focus

- 8 Megapixel (4K) IP camera
- Day/Night feature with removable IR cut filter for higher sensitivity and vibrant colors
- Automatic Back-Focus adjustment for simplified lens setup
- ONVIF Profile S
- SDHC memory card slot for alarm and scheduled image recording
- Bidirectional audio support
- Power input AC24V/DC12V and PoE



DIMENSIONS (MM)

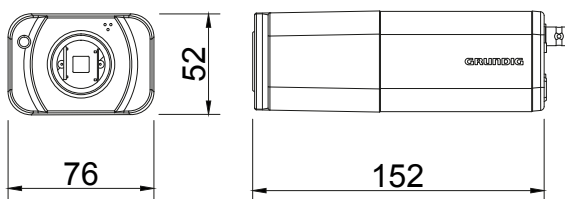

ACCESSORIES

GBR-WA03



SPECIFICATIONS

Image Sensor:	1/2.3" CMOS 8 MP
Pixels - Total:	3840(H) x 2160(V)
Digital Signal Processor (DSP):	Ambarella S2
Sensitivity Colour:	0.5 Lux@F1.2 (IRE50), 0.2 Lux@F1.2 (IRE30)
Sensitivity B&W:	0.1 Lux@F1.2 (IRE50), 0.02 Lux@ F1.2 (IRE30)
Col/B&W:	On/Off/Auto, IR-cut filter removable (ICR)
Lens Mount:	C/CS mount
Lens Drive Type:	DC auto iris, manual iris
Shutter Speed:	1 - 1/10.000 sec
WDR:	96dB (Shutter WDR)
BLC: Backlight:	On/Off
White Balance:	ATW, AWB, Manual, Push
Digital Noise Reduction (DNR):	On/off 2D/3D Noise Filter
D&N Switching Mode:	Light Sensor (Auto with LED), Light ON, Light OFF, SMART, Auto, Night, Day
Manual Trigger/Audio detect.:	On / Off
Schedule:	Daily, Weekly, Start Time and Duration
Alarm Event:	Image transfer or alarm message by FTP, Image transfer or alarm message by E-mail, recording on SD-card and enable alarm output
Camera ID:	20 character
Reverse:	Normal, Flip, Mirror, Vertical Mode [90°clockwise,90° counter clockwise], 180°
Privacy Zones/type:	5, rectangle, Color selection
Video Compression:	H.264 (MPEG4 Part10/AVC), MJPEG
Video Streaming:	Single Stream, Dual Stream, Triple Stream, Quad stream
Video Resolution:	8MP[3840x2160]/5MP[2592(x1944)]/3MP[2048x1536]/Full HD 1080p/SXGA/HD 720p/XGA/SVGA/4CIF/VGA/CIF
Frame Rate (Max@Resolution):	25fps@8MP, 25fps@6MP, 25fps@5MP, 25fps@3MP, 25fps@2MP, 25fps@1,3MP, etc.
ONVIF compliant:	Profile S
Audio:	G.726, G.711/ Bi-directional
Audio I/O:	Line In/Line Out [two way Audio]
Alarm Inputs/Outputs:	1 (5V, 10KΩ)/ 1 (max.300VDC/AC, 39W)
Access protection:	By log-in and Password, IP filter, IEEE802.1x
Number of Clients:	Up to 20 simultaneously
Recording at the Edge:	supports up to 64GB capacity Micro SD/SDHC/SDXC Card on Micro SD/SDHC CARD: Single Image Recording (JPEG), Video(AVI, LCK) on NAS: Video (AVI)
Recording Types:	MS IE 6.0 (or higher), Firefox, Google Chrome, Safari, Access over Mobile Devices
Web Browser:	IPV4/v6, TCP/IP, UDP, RTP, RTSP, HTTP, HTTPS, DHCP, PPPoE, UPnP, SMTP, ICMP, IGMP, SNMP, IEEE802.1x, QoS, ONVIF, FTP, ARP
Network Protocol:	Power, link, active/ 1Vpp, BNC
LED Indicator/Video Outputs:	-10°C ~ +50°C
Operating Temperature:	Humidity: 10 - 90% no condensation
Humidity:	Standards: CE, FCC, RoHS Compliant
Standards:	Supply Voltage: 12 VDC / PoE IEEE 802.3af
Supply Voltage:	Power Consumption/Weight: 4 W/ 0.36 kg
Power Consumption/Weight:	Dimensions (WxHxD): 76 x 52 x 152 mm
Dimensions (WxHxD):	



GCI-K1555Z

2 MP Full HD Box IP-Camera 18x AFZoom Modul ICR dWDR

- 2 Megapixel IP camera with Full HD 1080p, real time video streaming
- 18x Auto Focus Zoom (AFZ) lens
- ONVIF Profile S
- SDHC memory card slot for alarm and schedule image recording
- RS485 - multi-protocol support
- RS485 connection for PTZ control
- Bidirectional Audio Support
- Power input AC24V/DC12V and PoE

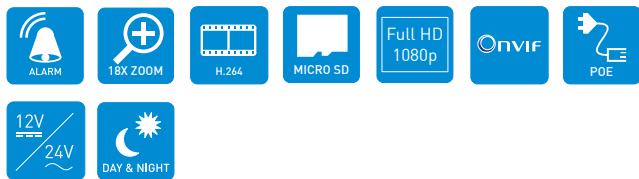

DIMENSIONS (MM)

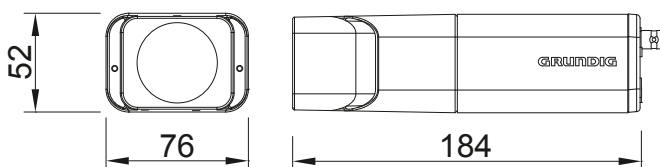

ACCESSORIES

GBR-WA03



SPECIFICATIONS

Image Sensor:	1/2,8" CMOS 2 Megapixel
Pixels - Total:	1920(H) x 1080(V)
Digital Signal Processor (DSP):	Ambarella A5S
Sensitivity Colour:	0.2 lux @ F1.6
Sensitivity B&W:	0.02 lux @ F1.6
CoI/B&W:	On/Off/Auto, IR-cut filter removable (ICR)
Focal Length:	4.7 – 84.6 mm
Viewing Angle:	H: 55.2°(Wide) ~ 3.2°(Tele)
Zoom Ratio:	x 18
Digital Zoom:	Off ~ 8x
Lens Drive Type:	DC auto iris, manual iris
Iris F-Number:	F= 1.6 – 360
Focus Adjustment:	Auto, Manual
Shutter Speed:	1 ~ 1/10.000 sec
BLC: Backlight:	On/Off + dWDR
White Balance:	Auto, Manual, Indoor, Outdoor, ATW
Privacy Zones:	5 zones, rectangle
Motion Detection:	On/ Off/ Sensitivity/ 4 Area setting
Region of Interest:	YES
Digital Noise Reduction (DNR):	2DNR/3DNR (Off/On)
Reverse:	Normal, Flip, Mirror, Vertical Mode (90°clockwise, 90° counter clockwise), 180°
Camera ID:	20 character
OSD:	Yes, multi language
Alarm Event:	Image transfer or alarm message by FTP, Image transfer or alarm message by E-mail, recording on SD-card and enable alarm output
Alarm I/O:	1 (5V, 10KΩ) / 1 (max.300VDC/AC, 39W)
SD Memory:	supports up to 32 GB capacity of micro SD/SDHC memory on Micro SD/SDHC CARD:
Recording Types:	Single Image Recording (JPEG), Video(AVI, LCK) on NAS: Video (AVI)
LED Indicator:	Power, link, active
Input/Output Sockets:	Power (Terminal 3-Pin), RJ-45, Micro SD Card Slot, 7-Pin Terminal (5-Pin Alarm IN/OUT, 2-Pin RS485), Audio IN/OUT (2xMicro Jack), Video BNC Output
Network Interface:	1x RJ-45 10/100Mbps
Video Outputs:	1Vpp, BNC
Interfaces/ Protocols:	RS-485/ Pelco-D, Pelco P, transparent Data channel
Web Browser:	MS IE 6.0 (or higher), Firefox, Google Chrome, Safari
Access protection:	By log-in and Password, IP filter, IEEE802.1x
Number of Clients:	Up to 20 simultaneously
Video Compression:	H.264 (MPEG-4Part 10/AVC), MJPEG
Video Streaming:	Single Stream, Dual Stream, Triple Stream, Quad stream
Video Resolution:	Full HD 1080p /SXGA / HD720p / XGA / SVGA / 4CIF/ VGA / CIF
Network Protocol:	IPv4/v6, TCP/IP, UDP, RTP, RTSP, HTTP, HTTPS, DHCP, PPPoE, UPnP, SMTP, ICMP, IGMP, SNMP, IEEE802.1x, QoS, ONVIF, FTP
Audio Compression:	G.711/G.726
Audio Communication:	Bi-directional
ONVIF compliant:	Profile S
Operating Temperature:	0°C ~ +40°C
Standards:	CE, FCC, RoHS Compliant
Supply Voltage:	12 VDC / 24 VAC / PoE
Power Consumption:	6 W
Weight:	0.45 kg
Dimensions (WxHxD):	184 x 76 x 52 mm



GCI-H2812W 2 MP Flat Fixed Dome IP-Camera 3.6mm Soft D/N

- 2 Megapixel colour IP camera, with real time 720P and 1080P video streams at 13FPS
- Lens: f = 3.6 mm
- ONVIF Profile S
- SDHC memory card slot for alarm and schedule image recording
- Indoor installation
- Built-in microphone
- Power input PoE



DIMENSIONS (MM)

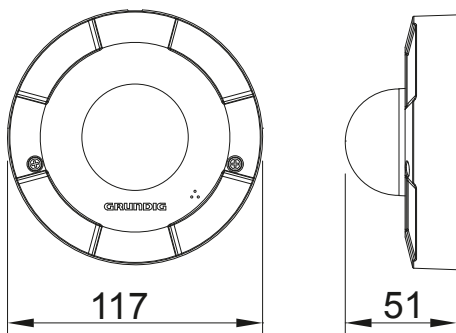

SPECIFICATIONS

Image Sensor:	1/2.7" CMOS, 2 Megapixel
Pixels - Total:	1920(H) x 1080(V)
Digital Signal Processor (DSP):	Ambarella 5S
Sensitivity Colour:	0.6 Lux@F1.8(IRE50), 0.1 Lux@F1.8(IRE30)
Lens Focal Length:	3.6 mm
Viewing Angle:	88°
Iris F-Number:	F= 1.8
Digital Zoom:	Off ~ 8x
Shutter Speed:	1 ~ 1/10.000 sec
AGC:	Off, 1~3(Auto) or 1~9 (Manual)
WDR:	D-WDR (Digital wide dynamic range)
BLC: Back Light:	On/Off
White Balance:	ATW, AWB, Manual
Privacy Zones:	5 zones, rectangle
Motion Detection:	On/ Off/ Sensitivity/ Area setting
Tampering Alarm:	On/Off
Digital Noise Reduction (DNR):	Off, 3DNR Low/Middle/High, SPQ+3DNR
Reverse:	Normal, Flip, Mirror, Vertical Mode (90°clockwise, 90° counter clockwise), 180°
Camera ID:	20 character
OSD:	Yes, multi language
Alarm Event:	Image transfer or alarm message by FTP, Image transfer or alarm message by E-mail, recording on SD-card and send HTTP notification
SD Memory:	supports up to 32 GB capacity of micro SD/SDHC memory on Micro SD/SDHC CARD:
Recording Types:	Single Image Recording [JPEG], Video[AVI, LCK] on NAS: Video [AVI]
Input/Output Sockets:	RJ-45, Micro SD Card Slot
Network Interface:	1x RJ-45 10/100Mbs
Audio Inputs:	built in Microphone
Web Browser:	MS Internet Explorer 6.0 (or higher), Firefox, Google Chrome, Safari
Access protection:	By log-in and Password, IP filter, IEEE802.1x
Number of Clients:	Up to 20 simultaneously
Video Compression:	H.264 (MPEG-4Part 10/AVC), MJPEG
Video Streaming:	Single Stream, Dual Stream, Triple Stream, Quad stream
Video Resolution:	Full HD 1080p /SXGA / HD720p / XGA / SVGA / 4CIF/ VGA / CIF IPv4/v6, TCP/IP, UDP, RTP, RTSP, HTTP, HTTPS, DHCP, PPPoE, UPnP, SMTP, ICMP, IGMP, SNMP, IEEE802.1x, QoS, ONVIF, ARP
Network Protocol:	Profile S
ONVIF compliant:	Profile S
Operating Temperature:	-10°C ~ +50°C
Humidity:	0 ~ 90%RH
Standards:	CE, FCC, RoHS Compliant
Supply Voltage:	PoE IEEE 802.3af
Power Consumption:	3.5 W
Weight:	0.18 kg
Dimensions (WxHxD):	Ø 117 x 51 mm



GCI-K2812W

2 MP Full HD Flat Fixed Dome IP-Camera 3.6mm Soft D/N dWDR IP66

- 2 Megapixel colour IP camera with real time, 1080P video streams
- Lens: f = 3.6 mm
- Weatherproof outdoor casing (IP66)
- ONVIF Profile S
- SDHC memory card slot for alarm and scheduled image recording
- Power input PoE



DIMENSIONS (MM)

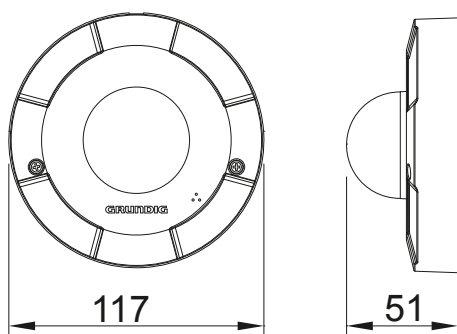

SPECIFICATIONS

Image Sensor:	1/2.7" CMOS, 2 Megapixel
Pixels - Total:	1920(H) x 1080(V)
Digital Signal Processor (DSP):	Ambarella A5S
Sensitivity Colour:	0.6 Lux@F1.8(IRE50), 0.1 Lux@F1.8(IRE30)
Lens Focal Length:	3.6 mm
Viewing Angle:	88°
Iris F-Number:	F= 1.8
Digital Zoom:	Off ~ 8x
Shutter Speed:	1 ~ 1/10.000 sec
BLC: Back Light:	On/Off
WDR:	D-WDR (Digital wide dynamic range)
White Balance:	ATW, AWB, Manual
Privacy Zones:	5 zones, rectangle
Motion Detection:	On/ Off/ Sensitivity/ Area setting
Tampering Alarm:	On/Off
Digital Noise Reduction (DNR):	Off, 3DNR Low/Middle/High, SPQ+3DNR
Reverse:	Normal, Flip, Mirror, Vertical Mode (90°clockwise,90° counter clockwise), 180°
Camera ID:	20 character
OSD:	Yes, multi language
Alarm Event:	Image transfer or alarm message by FTP, Image transfer or alarm message by E-mail, recording on SD-card and send HTTP notification
SD Memory:	supports up to 32 GB capacity of micro SD/SDHC memory on Micro SD/SDHC CARD:
Recording Types:	Single Image Recording (JPEG), Video(AVI, LCK) on NAS: Video (AVI)
Input/Output Sockets:	RJ-45, Micro SD Card Slot
Network Interface:	1x RJ-45 10/100Mbps
Web Browser:	MS Internet Explorer 6.0 (or higher), Firefox, Google Chrome, Safari
Access protection:	By log-in and Password, IP filter, IEEE802.1x
Number of Clients:	Up to 20 simultaneously
Video Compression:	H.264 (MPEG-4Part 10/AVC), MJPEG
Video Streaming:	Single Stream, Dual Stream, Triple Stream, Quad stream
Video Resolution:	Full HD 1080p / SXGA / HD720p / XGA / SVGA / 4CIF / VGA / CIF
Network Protocol:	IPv4/v6, TCP/IP, UDP, RTP, RTSP, HTTP, HTTPS, DHCP, PPPoE, UPnP, SMTP, ICMP, IGMP, SNMP, IEEE802.1x, QoS, ONVIF, ARP
ONVIF compliant:	Profile S
Protection Rating:	IP66
Operating Temperature:	-10°C ~ +50°C
Standards:	CE, FCC, RoHS Compliant
Supply Voltage:	PoE IEEE 802.3af
Power Consumption:	3.5 W
Weight:	0.18 kg
Dimensions (WxHxD):	Ø 117 x 51 mm



GCI-F2812W
3 MP Full HD Flat Fixed Dome IP-Camera
3.6mm Soft D/N

- 3 Megapixel IP camera with Full - HD 1080P real time video streaming
- Lens: f = 3.6 mm
- H.264 & MJPEG compression modes
- ONVIF Profile S
- SDHC memory card slot for alarm and scheduled image recording
- Indoor installation
- Built-in microphone



DIMENSIONS (MM)

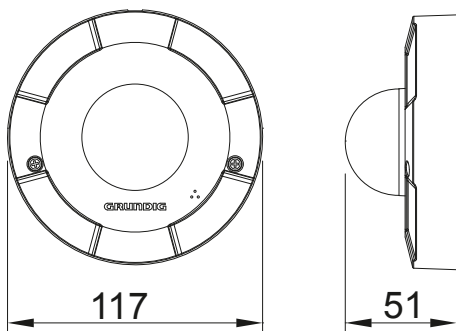

SPECIFICATIONS

Image Sensor:	1/2.8" Sony Exmor™ CMOS, 3 Megapixels
Pixels - Total:	2048 (H) x 1536 (V)
Digital Signal Processor (DSP):	Ambarella A5S
Sensitivity Colour:	0.6 Lux@F1.8(IRE50), 0.1 Lux@F1.8(IRE30)
Lens Focal Length:	3.6 mm
Viewing Angle:	88°
Iris F-Number:	F= 1.8
Digital Zoom:	Off ~ 8x
Shutter Speed:	1 ~ 1/10.000 sec
AGC:	Off, 1~3(Auto) or 1~9 (Manual)
WDR:	75dB (Digital Wide Dynamic Range) Off/Low/Middle/High
BLC: Back Light:	On/Off
White Balance:	ATW, AWB, Manual
Privacy Zones:	5 zones, rectangle
Motion Detection:	On/ Off/ Sensitivity/ Area setting
Tampering Alarm:	On/Off
Digital Noise Reduction (DNR):	Off, 3DNR Low/middle/High, SPQ + 3DNR
Reverse:	Normal, Flip, Mirror, Vertical Mode (90°clockwise,90° counter clockwise), 180°
Camera ID:	20 character
OSD:	Yes, multi language
Alarm Event:	Send message by FTP or/and Email, Upload image by FTP or/and Email, Send HTTP notification,Record to Micro SD Card
SD Memory:	supports up to 32 GB capacity of micro SD/SDHC memory on Micro SD/SDHC CARD:
Recording Types:	Single Image Recording (JPEG), Video(AVI, LCK) on NAS: Video (AVI)
Input/Output Sockets:	RJ-45, Micro SD Card Slot
Network Interface:	1x RJ-45 10/100Mbps
Audio Inputs:	built in Microphone
Web Browser:	MS Internet Explorer 6.0 (or higher), Firefox, Google Chrome, Safari
Access protection:	By log-in and Password, IP filter, IEEE802.1x
Number of Clients:	Up to 20 simultaneously
Video Compression:	H.264 (MPEG4 Part10/AVC), MJPEG
Video Resolution:	3MP (2048x1536) / Full HD 1080p /SXGA / HD720p / XGA / SVGA / 4CIF/ VGA / CIF
Video Streaming:	Single Stream, Dual Stream, Triple Stream, Quad stream
Network Protocol:	IPv4/v6, TCP/IP, UDP, RTP, RTSP, HTTP, HTTPS, DHCP, PPPoE, UPnP, SMTP, ICMP, IGMP, SNMP, IEEE802.1x, QoS, ONVIF, ARP
ONVIF compliant:	Profile S
Audio Compression:	G.711/G.726
Audio Communication:	Uni-directional
Operating Temperature:	-10°C ~ +50°C
Humidity:	0 ~ 90%RH
Standards:	CE, FCC, RoHS Compliant
Supply Voltage:	PoE IEEE 802.3af
Power Consumption:	3.5 W
Weight:	0.18 kg
Dimensions (WxHxD):	Ø 117 x 51 mm



GCI-K0622D

2 MP Indoor Dome IP-Camera 3~10.5mm ICR

- 2 Megapixel colour IP camera, with real time 720P and 1080P video streams at 13FPS
- ONVIF Profile S
- SDHC memory card slot for alarm and scheduled image recording
- Bidirectional audio support
- Power input AC24V/DC12V and PoE

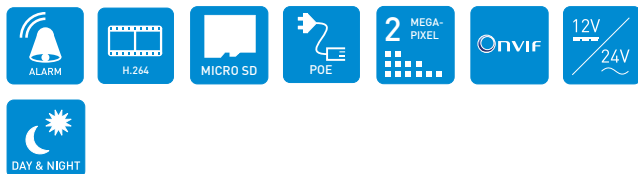

DIMENSIONS (MM)

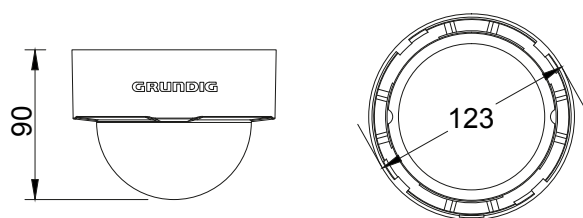

SPECIFICATIONS

Image Sensor:	1/2.7" CMOS, 2 Megapixel
Pixels - Total:	1920(H) x 1080(V)
Digital Signal Processor (DSP):	Ambarella A5S
Sensitivity Colour:	0.5 Lux@F1.2 (IRE50), 0.2 Lux@F1.2 (IRE30)
Sensitivity B&W:	0.1 Lux@F1.2 (IRE50), 0.02 Lux@ F1.2 (IRE30)
Col/B&W:	On/Off/Auto, IR-Cut Filter Removable(ICR)
Lens Focal Length:	3~10.5mm
Viewing Angle:	approx. 90°(w) ~ 33° (t)
Iris F-Number:	F= 1.2 ~ 360
Lens Drive Type:	Auto iris (DC)
Focus Adjustment:	Manual
Shutter Speed:	1 - 1/10.000 sec
WDR:	D-WDR (Digital Wide Dynamic Range) Off/Low/Middle/High
BLC (Back Light):	On/Off
White Balance:	ATW, AWB, Manual, Push
Digital Noise Reduction (DNR):	Off, 3DNR Low, 3DNR Mid, 3DNR Hi, SPQ , SPQ+3DNR Low, SPQ+3DNR Mid, SPQ+3DNR Hi
D&N Switching Mode:	SMART, Auto, Night, Day
Manual Trigger/audio detect.:	On, Off/ Off, On
Schedule:	Single Day or Week, Time [Start, Duration], DAY or NIGHT Mode
Alarm Event:	Image Transfer or Alarm Message by FTP, Image Transfer or Alarm Message by E-mail, Recording on SD-Card, enable Alarm Output and send HTTP Notification
Reverse:	Normal, Flip, Mirror, Vertical Mode [90°clockwise,90° counter clockwise], 180°
Privacy zone:	5, rectangle
Network:	10/100 Base-T
Video Compression:	H.264 (MPEG-4Part 10/AVC), MJPEG
ONVIF compliant:	Profile S
Video Streaming:	Single Stream, Dual Stream, Triple Stream, Quad stream
Video Resolution:	Full HD 1080p/ SXGA/ HD 720p/ XGA/SVGA/ 4CIF/ VGA/ CIF
Frame Rate (Max@Resolution):	13fps@2MP, 25fps@1,3MP, etc.
Audio:	G.726, G.711, Bi-directional
Audio Input/Output:	Line In/Line Out (two way Audio)
Alarm I/O:	1 (5V, 10KΩ) / 1 (max.300VDC/AC, 39W)
Access protection:	By log-in and Password, IP filter, IEEE802.1x
Number of Clients:	Up to 20 simultaneously
Micro SDHC memory:	Supports up to 32GB
Recording Types:	on Micro SD/SDHC CARD: Single Image Recording (JPEG), Video(AVI, LCK) on NAS: Video (AVI)
Web Browser:	MS Internet Explorer 6.0 (or higher), Firefox, Google Chrome, Safari, Access over Mobile Devices
Network Protocol:	IPv4/v6, TCP/IP, UDP, RTP, RTSP, HTTP, HTTPS, DHCP, PPPoE, UPnP, SMTP, ICMP, IGMP, SNMP, IEEE802.1x, QoS, ONVIF, FTP, ARP
Input/Output Sockets:	Power (Terminal 3-Pin), RJ-45, Micro SD Card Slot, 8-Pin Terminal [4-Pin Alarm IN/OUT],Audio IN/OUT [4-Pin], Video Output
Operating Temperature:	-10°C ~ +50°C
Humidity:	10 ~ 90% no condensation
Standards:	CE, FCC, RoHS Compliant
Supply Voltage:	12 VDC / 24 VAC / PoE
Power Consumption/Weight:	10 W/0.31 kg
Dimensions (WxHxD):	Ø 123 x 90 mm



GCI-K1627D

2 MP Full HD Indoor Dome IP-Camera 3~10.5mm ICR IR 21 LED WDR

- EXMOR™ sensor for low light sensitivity
- XARINA™ DSP for advanced functionality
- 2 Megapixel IP camera with real time Full HD 1080P video streams
- High frame rate - 60 frames per second at Full HD resolution
- Day/Night feature with removable IR cut filter for higher sensitivity and vibrant colors
- 0 Lux: Integrated IR LED illuminator for night-time operation
- WDR (Wide Dynamic Range) for extreme backlight applications
- ONVIF Profile S

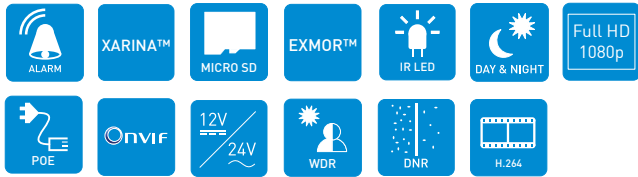

DIMENSIONS (MM)

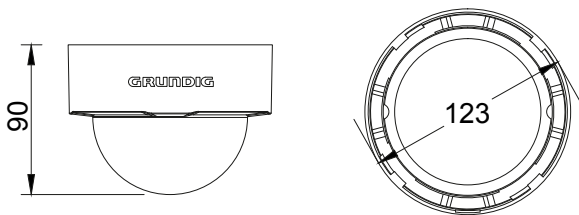

SPECIFICATIONS

Image Sensor:	1/2.8" Sony Exmor™ CMOS
Pixels - Total:	1920(H) x 1080(V)
Digital Signal Processor (DSP):	Sony Xarina Solution
Sensitivity Colour:	0.01 Lux@F1.4 (IRE30), 0.05 Lux@F1.4 (IRE50)
Sensitivity B&W:	0.001 Lux@F1.4 (IRE30), 0.01 Lux@F1.4 (IRE50)
Col/B&W:	On/Off/Auto, IR-cut filter removable (ICR)
Lens Focal Length:	3 - 10.5 mm
Viewing Angle:	approx. 93°(w) ~ 32° (t)
Iris F-Number:	F= 1.4 ~ 360
Lens Drive Type:	Auto iris (DC)
Focus Adjustment:	Manual
IR LED:	21 pcs., 90° beaming angle
Max. IR Distance:	15/25 m (according to scene reflexion)
Wavelength:	850nm
Shutter Speed:	1 ~ 1/10.000 sec
WDR:	96dB (Shutter WDR)
BLC: Back Light:	On/Off
White Balance:	AWB, Auto no boundary, ATW, Indoor, Outdoor, Manual
Digital Noise Reduction (DNR):	On/off 2D/3D Noise Filter
Digital Image Stabilization (DIS):	Off/On
D&N Switching Mode:	Light Sensor (Auto with LED), Light ON, Light OFF, SMART, Auto, Night, Day
Manual Trigger:	On, Off
Schedule:	Single Day or Week, Time (Start, Duration), DAY or NIGHT Mode
Alarm Event:	Image Transfer or Alarm Message by FTP, Image Transfer or Alarm Message by E-mail, Recording on SD-Card, enable Alarm Output and send HTTP Notification
Reverse:	Normal, Flip, Mirror, Vertical Mode, 180°
Privacy Zones:	5/ rectangle, Color selection
Video Compression:	H.264 (MPEG-4Part 10/AVC), MJPEG
ONVIF compliant:	Profile S
Video Streaming:	Single Stream, Dual Stream, Triple Stream, Quad stream
Video Resolution:	Full HD 1080p / SXGA / HD720p / XGA / SVGA / 4CIF / VGA / CIF
Frame Rate (Max@Resolution):	50fps@2MP, 25fps@2MP, 50fps@1,3MP, 25fps@1,3MP, etc.
Audio:	G.726, G.711, bi-directional
Audio I/O:	Line In/Line Out (two way Audio)
Alarm I/O:	1 (5V, 10KΩ) / 1 (max.300VDC/AC, 39W)
Access protection:	By log-in and Password, IP filter, IEEE802.1x
Number of Clients:	Up to 20 simultaneously
Micro SDHC memory:	Supports up to 64GB
Recording Types:	on Micro SD/SDHC CARD, Single Image Recording (JPEG) Video (AVI)
Web Browser:	MS Internet Explorer 6.0 (or higher), Firefox, Google Chrome, Safari, Access over Mobile Devices
Network Protocol:	IPv4/v6, TCP/IP, UDP, RTP, RTSP, HTTP, HTTPS, DHCP, PPPoE, UPnP, SMTP, ICMP, IGMP, SNMP, IEEE802.1x, QoS, ONVIF, FTP, ARP
Input/Output Sockets:	Power (Terminal 3-Pin), RJ-45, Micro SD Card Slot, 8-Pin Terminal (4-Pin, Alarm IN/OUT), Audio IN/OUT (4-Pin), Video Output
Operating Temperature:	-10°C ~ +50°C
Humidity:	10 ~ 90% no condensation
Standards:	CE, FCC, RoHS Compliant
Supply Voltage:	12 VDC / 24 VAC / PoE IEEE 802.3af
Power Consumption:	10 (LED ON) W
Weight:	0.31 kg
Dimensions (WxHxD):	Ø 123 x 90 mm



GCI-K1677D

2 MP Full HD Indoor Dome IP-Camera 3~9mm AFZ Modul/P-Iris ICR IR 21 LED WDR

- EXMOR™ sensor for low light sensitivity
- XARINA™ DSP for advanced functionality
- 2 Megapixel IP camera with real time, Full HD, 1080P video streams
- High frame rate - 60 frames per second at Full HD resolution
- Tamron P-Iris Lens with Auto Focus Zoom Module
- Day/Night feature with removable IR cut filter for higher sensitivity and vibrant colors
- 3 Way Axis Gimbal, wall mountable
- WDR (Wide Dynamic Range) for extreme backlight applications
- ONVIF Profile S



DIMENSIONS (MM)

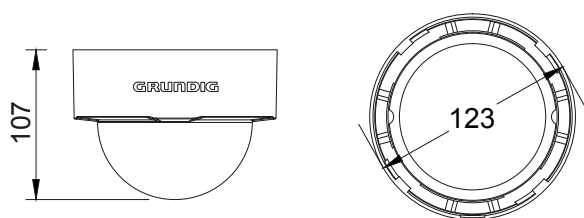

SPECIFICATIONS

Image Sensor:	1/2.8" Sony Exmor™ CMOS
Pixels - Total:	1920(H) x 1080(V)
Digital Signal Processor (DSP):	Sony Xarina Solution
Sensitivity Colour:	0.01 Lux@F1.4 (IRE30), 0.05 Lux@F1.4 (IRE50)
Sensitivity B&W:	0.001 Lux@F1.4 (IRE30), 0.01 Lux@F1.4 (IRE50)
Col/B&W:	On/Off/Auto, IR-cut filter removable (ICR)
Lens Focal Length/ Viewing Angle:	3 - 9 mm/ approx. 93°(w) ~ 32° (t)
Iris F-Number:	F= 1.2 ~ 360
Lens Drive Type:	Tamron® Auto-Focus-Zoom Module, P-Iris
Focus Adjustment:	Manual
IR LED:	21 pcs., 90° beaming angle
Max. IR Distance:	15/25 m (according to scene reflexion)
Wavelength:	850nm
Shutter Speed:	1 - 1/10.000 sec
WDR:	96dB (Shutter WDR)
White Balance:	AWB, Auto no boundary, ATW, Indoor, Outdoor, Manual
Digital Noise Reduction (DNR):	On/off 2D/3D Noise Filter
Digital Image Stabilization (DIS):	Off/On
D&N Switching Mode:	Light Sensor (Auto with LED), Light ON, Light OFF, SMART, Auto, Night, Day
Schedule:	Single Day or Week, Time (Start, Duration), DAY or NIGHT Mode
Alarm Event:	Image Transfer or Alarm Message by FTP, Image Transfer or Alarm Message by E-mail, Recording on , SD-Card, enable Alarm Output and send HTTP Notification
Reverse:	Normal, Flip, Mirror, Vertical Mode, 180°
Privacy Zones:	5, rectangle, Color selection
Network:	10/100 Base-T
Video Compression:	H.264 (MPEG-4Part 10/AVC), MJPEG
ONVIF compliant:	Profile S
Video Streaming:	Single Stream, Dual Stream, Triple Stream, Quad stream
Video Resolution:	Full HD 1080p/ SXGA/ HD 720p/ XGA/SVGA/ 4CIF/ VGA/ CIF
Frame Rate (Max@Resolution):	50fps@2MP, 25fps@2MP, 50fps@1,3MP, 25fps@1,3MP, etc.
Audio:	G.726, G.711, Bi-directional
Audio I/O:	Line In/Line Out (two way Audio)
Alarm Inputs/ Outputs:	1 (5V, 10K) / 1 (max.300VDC/AC, 39W)
Access protection:	By log-in and Password, IP filter, IEEE802.1x
Number of Clients:	Up to 20 simultaneously
Micro SDHC memory:	Supports up to 64GB
Recording Types:	on Micro SD/SDHC CARD , Single Image Recording (JPEG), Video (AVI)
Web Browser:	MS Internet Explorer 6.0 (or higher), Firefox, Google Chrome, Safari, Access over Mobile Devices
Network Protocol:	IPv4/v6, TCP/IP, UDP, RTP, RTSP, HTTP, HTTPS, DHCP, PPPoE, UPnP, SMTP, ICMP, IGMP, SNMP, IEEE802.1x, QoS, ONVIF, FTP, ARP
LED Indicator/ Video Outputs:	Power, link, active/ 1Vpp
Input/Output Sockets:	Power (Terminal 3-Pin), RJ-45, Micro SD Card Slot, 8-Pin Terminal (4-Pin Alarm IN/OUT), Audio IN/OUT (4-Pin), Video Output
Operating Temperature:	-10°C ~ +50°C
Humidity:	10 ~ 90% no condensation
Standards:	CE, FCC, RoHS Compliant
Supply Voltage:	12 VDC/ 24 VAC / PoE
Power Consumption:	PoE IEEE 802.3af/ 10 (LED ON) W
Weight:	0.31 kg
Dimensions (WxHxD):	∅ 123 x 107 mm



GCI-F0676D

3 MP Full HD Indoor Dome IP-Camera 3~9mm AFZ Modul/P-Iris ICR IR 24 LED

- 3 Megapixel IP camera with Full - HD, 1080P, real time video streaming
- Tamron P-Iris lens with Auto Focus Zoom module
- Day/Night feature with removable IR cut filter for higher sensitivity and vibrant colors
- 0 Lux: Integrated IR LED illuminator for night-time operation
- ONVIF Profile S
- SDHC memory card slot for alarm and scheduled image recording



DIMENSIONS (MM)

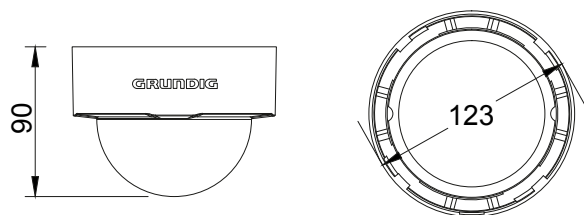

SPECIFICATIONS

Image Sensor:	1/2.8" Sony Exmor™ CMOS, 3 Megapixels
Pixels - Total:	2048 (H) x 1536 (V)
Digital Signal Processor (DSP):	Ambarella A5S
Sensitivity Colour:	0.5 Lux@F1.2 (IRE50), 0.2 Lux@F1.2 (IRE30)
Sensitivity B&W:	0.1 Lux@F1.2 (IRE50), 0.02 Lux@ F1.2 (IRE30)
Col/B&W:	On/Off/Auto, IR-cut filter removable (ICR)
Lens Focal Length:	3 ~ 9 mm
Viewing Angle:	approx. 104°(H) ~ 33°(V)
Zoom Ratio:	x 3
Digital Zoom:	On/Off
Lens Drive Type:	Tamron® Auto-Focus-Zoom Module, P-Iris
Iris F-Number:	F= 1.2 ~ 360
Focus Adjustment:	Auto, Manual
IR LED:	24 pcs., 90° Beaming Angle
Max. IR Distance:	15/25 m (according to scene reflexion)
Wavelength:	850nm
Shutter Speed:	1 ~ 1/10.000 sec
WDR:	75dB (Digital Wide Dynamic Range) Off/Low/Middle/High
BLC: Back Light:	On/Off
White Balance:	ATW, AWB, Manual, Push
Digital Noise Reduction (DNR):	On/off 2D/3D Noise Filter
D&N Switching Mode:	Light Sensor (Auto with LED), Light ON, Light OFF, SMART, Auto, Night, Day
Manual Trigger:	On, Off
Audio detection:	Off, On
Schedule:	Single Day or Week, Time (Start, Duration), DAY or NIGHT Mode
Alarm Event:	Image Transfer or Alarm Message by FTP, Image Transfer or Alarm Message by E-mail, Recording on SD-Card, enable Alarm Output and send HTTP Notification
Reverse:	Normal, Flip, Mirror, Vertical Mode (90°clockwise,90° counter clockwise), 180°
Privacy Zones:	5, rectangle, Color selection
Network:	10/100 Base-T
Video Compression:	H.264 (MPEG-4Part 10/AVC), MJPEG
ONVIF compliant:	Profile S
Video Streaming:	Single Stream, Dual Stream, Triple Stream, Quad stream
Video Resolution:	3MP (2048x1536) / Full HD 1080p /SXGA / HD720p / XGA / SVGA / 4CIF/ VGA / CIF
Frame Rate (Max@Resolution):	15fps@3MP, 25fps@2MP, 25fps@1,3MP, etc.
Audio:	G.726, G.711/ Bi-directional
Audio Input/Output:	Line In/Line Out (two way Audio)
Alarm I/O:	1 (5V, 10KΩ) / 1 (max.300VDC/AC, 39W)
Access protection:	By log-in and Password, IP filter, IEEE802.1x
Number of Clients:	Up to 20 simultaneously
SD Memory:	Supports up to 32GB
Recording Types:	on Micro SD/SDHC CARD: Single Image Recording (JPEG), Video(AVI, LCK) on NAS: Video (AVI)
Web Browser:	MS Internet Explorer 6.0 (or higher), Firefox, Google Chrome, Safari, Access over Mobile Devices
Network Protocol:	IPv4/v6, TCP/IP, UDP, RTP, RTSP, HTTP, HTTPS, DHCP, PPPoE, UPnP, SMTP, ICMP, IGMP, SNMP, IEEE802.1x, QoS, ONVIF, FTP, ARP
Input/Output Sockets:	Power (Terminal 3-Pin), RJ-45, Micro SD Card Slot, 8-Pin Terminal (4-Pin Alarm IN/OUT),Audio IN/OUT (4-Pin), Video Output
Operating Temperature:	-10°C ~ +50°C
Humidity:	10 ~ 90% no condensation
Standards:	CE, FCC, RoHS Compliant
Supply Voltage:	12 VDC / PoE
Power Consumption:	10 (LED on) W
Dimensions (w x h x d)/Weight:	Ø 123 x 90 mm/ 0.35 kg



GCI-G1536F

5 MP 360° Fisheye IP Camera ICR IR 6 LED

- 5 Megapixel, CMOS, Day/Night camera
- 360° field of view
- Integrated IR LED illuminator for night-time operation
- ONVIF Profile S
- H.264 & MJPEG compression modes (max. 25 fps)
- SDHC memory card slot for alarm and scheduled image recording
- Ceiling or wall mount options
- Power input AC24V/DC12V and PoE
- Built-in microphone and loudspeaker

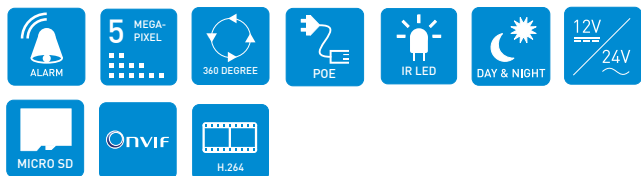

DIMENSIONS (MM)

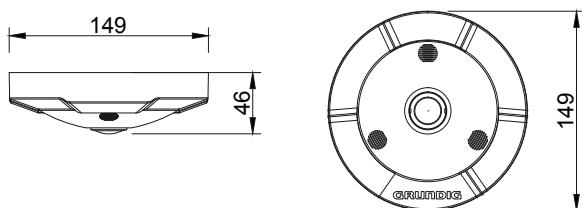

SPECIFICATIONS

Image Sensor:	1/2,5" CMOS 5 Megapixel
Pixels - Total:	2592 (H) x 1944 (V)
Digital Signal Processor (DSP):	Ambarella A55
Sensitivity Colour/B&W:	0.2 Lux@F2.8/ 0.02 Lux@F2.8
Col/B&W:	On/Off/SMART, IR-cut filter removable (ICR)
Lens Focal Length:	1.05 mm
Viewing Angle:	180° circle (full hemisphere)
Digital Zoom:	Off ~ 8x
Iris F-Number:	F 2.8
Lens Drive Type:	Fixed Iris
IR LED/max. IR distance:	6 pieces/ Ø 6 m @ 3m
Wavelength:	850nm
Shutter Speed:	1 ~ 1/10.000 sec
PTZ Control:	digital Pan/Tilt/Zoom
WDR:	D-WDR (Digital wide dynamic range)
BLC: Back Light:	On/Off
White Balance:	ATW, AWB, Manual, Push
Privacy Zones:	5/ rectangle
Manual Trigger:	On, Off
Audio detection:	Off, On
Schedule:	Single Day or Week, Time (Start, Duration), DAY or NIGHT Mode
Reverse:	Normal, Flip, Mirror, Vertical Mode [90°clockwise, 90° counter clockwise], 180°
Digital Noise Reduction (DNR):	Off, 3DNR Low/Middle/High, SPQ+3DNR
D&N Switching Mode:	Light Sensor (Auto with LED), Light ON, Light OFF, SMART, Auto, Night, Day
Alarm Event:	Image Transfer or Alarm Message by FTP, Image Transfer or Alarm Message by E-mail, Recording on SD-Card, enable Alarm Output and send HTTP Notification
Access protection:	By log-in and Password, IP filter, IEEE802.1x
Number of Clients:	Up to 20 simultaneously
Video Compression:	H.264 (MPEG-4Part 10/AVC), MJPEG
ONVIF compliant:	Profile S
Video Streaming:	Single Stream, Dual Stream, Triple Stream, Quad stream
Video Resolution:	5MP[2592x1944]/3MP[2048x1536]/Full HD 1080p/SXGA/HD 720p/XGA/SVGA/4CIF/VGA/CIF
Frame Rate (Max@Resolution):	12fps@5MP, 15fps@3MP, 25fps@2MP, 25fps@1,3MP, etc.
Audio:	G.726, G.711/ Bi-directional built in Microphone and loudspeaker, over an optional "all in one cable" Line In/Out
Alarm I/O:	1 (5V, 10KΩ) / 1 (max.300VDC/AC, 39W)
Recording at the Edge:	supports up to 32GB capacity Micro SD/SDHC Card
Recording Types:	on Micro SD/SDHC CARD: Single Image Recording (JPEG), Video(AVI, LCK) on NAS: Video (AVI)
Web Browser:	MS Internet Explorer 6.0 (or higher), Firefox, Google Chrome, Safari
Network Protocol:	IPv4/v6, TCP/IP, UDP, RTP, RTSP, HTTP, HTTPS, DHCP, PPPoE, UPnP, SMTP, ICMP, IGMP, SNMP, IEEE802.1x, QoS, ONVIF, FTP, ARP
Operating Temperature:	-10°C ~ +50°C
Humidity:	10 ~ 90% no condensation
Standards:	CE, FCC, RoHS Compliant
Supply Voltage:	12 VDC / 24 VAC / PoE IEEE 802.3af
Power Consumption:	8 W/
Weight:	0.35 kg
Dimensions (WxHxD):	Ø149 x 46 mm mm



GCI-M0566F 6 MP 360° Fisheye IP Camera

- 6 Megapixel CMOS, Day/Night camera
- 360° field of view
- De-warping functionality built-In
- 0 Lux: Integrated IR LED illuminator for night-time operation
- ONVIF Profile S
- SDHC memory card slot for alarm and scheduled image recording
- Ceiling or wall mount options
- Power input AC24V/DC12V and PoE
- Built-in microphone and loudspeaker

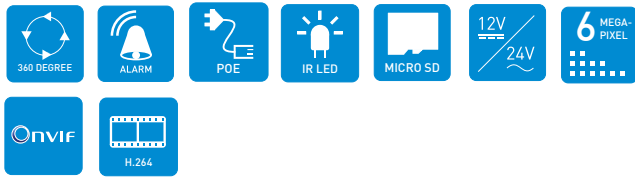

DIMENSIONS (MM)

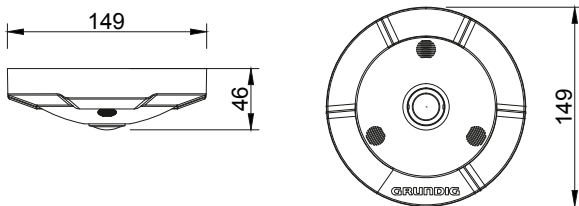

SPECIFICATIONS

Image Sensor:	1/1.8" Progressive Sony
Pixels - Total:	3072 x 2048
Digital Signal Processor (DSP):	Ambarella S2
Sensitivity Colour/B&W:	0.2 Lux@F2.8/ 0.02 Lux@F2.8
Col/B&W:	On/Off/SMART, IR-cut filter removable (ICR)
Lens:	Stereo Projection 1/2.5" Fisheye
Lens Focal Length/Viewing Angle:	1.05 mm / 180° @ Full Resolution
Iris F-Number:	F 2.8
Lens Drive Type:	Fixed Iris
Digital Zoom:	Yes
IR LED/ Max. IR Distance:	6 pieces/ Ø 6 m @ 3m
Wavelength:	850nm
Shutter Speed/PTZ Control:	1 ~ 1/10.000 sec/ digital Pan/Tilt/Zoom
WDR:	D-WDR (Digital Wide Dynamic Range) Off/Low/Middle/High
BLC: Back Light:	On/Off
White Balance:	ATW, AWB, Manual
Privacy Zones/ Type:	5 / rectangle
Schedule:	Daily, Weekly, Start Time and Duration
Reverse:	Normal, Flip, Mirror, Vertical Mode (90°clockwise,90° counter clockwise), 180°
Digital Noise Reduction (DNR):	Off, 3DNR Low/Middle/High, SPQ+3DNR
D&N Switching Mode:	Light Sensor (Auto with LED), Light ON, Light OFF, SMART, Auto, Night, Day
Alarm Event:	Image Transfer or Alarm Message by FTP, Image Transfer or Alarm Message by E-mail, Recording on SD-Card, enable Alarm Output and send HTTP Notification
Access protection:	By log-in and Password, IP filter, IEEE802.1x
Number of Clients:	Up to 20 simultaneously
Video Compression:	H.264 (MPEG-4Part 10/AVC), MJPEG
ONVIF compliant:	Profile S
Video Streaming:	Single Stream, Dual Stream, Triple Stream, Quad stream Backend dewarp:3072x2048,1920x1080, 1280x1024, 1280x720, 1024x768, 800x600, 720x576, 640x480, 352x288, 320x240 Front End Dewarp: 2048x2048, 2048x1536,1920x1080, 1600x1200,1408x1408, 960x960, 960x720, 960x544 25fps@6MP, 25fps@4MP, 25fps@3MP, 50fps@2MP, 50fps@1.3MP, etc.
Frame Rate (Max@Resolution):	25fps@6MP, 25fps@4MP, 25fps@3MP, 50fps@2MP, 50fps@1.3MP, etc.
Frontend Dewarp function:	Yes, 2 Streams(4MP&2MP)
Backend Dewarp function:	Yes, 6MP, up to 4 Streams
Audio:	G.726, G.711, Bi-directional
Audio I/O:	Line In/Line Out (two way Audio)
Alarm I/O:	1 (5V, 10KΩ) / 1 (max.300VDC/AC, 39W)
Web Browser:	MS Internet Explorer 6.0 (or higher), Firefox, Google Chrome, Safari
Number of Clients:	Up to 20 simultaneously
Network Protocol:	IPv4, IPv6, TCP/IP, UDP, RTP, RTSP, HTTP, HTTPS, ICMP, FTP, SMTP, DHCP, PPPoE, UPnP, IGMP, 802.1X and SNMP
SD Memory:	supports up to 32 GB capacity of micro SD/SDHC memory
Input/Output Sockets:	Power (Terminal 3-Pin), RJ-45, Micro SD Card Slot, Alarm Terminal 4-Pin (Alarm In 2-Pin, Alarm Out 2-Pin)
Mount:	Indoor Ceiling & Wall
Operating Temperature:	-10°C ~ +50°C
Humidity:	10 ~ 90% no condensation
Standards:	CE, FCC, RoHS Compliant
Supply Voltage:	12 VDC / 24 VAC / PoE
Dimensions (WxHxD):	Ø149 x 46 mm mm



GCI-K1527V

2 MP Full HD VF Dome IP-Camera 3~10.5mm ICR IR 24 LED WDR

- EXMOR™ sensor for low light sensitivity
- XARINA™ DSP for advanced functionality
- 2 Megapixel IP camera with Full - HD, 1080P, real time video streaming
- High frame rate - 60 frames per second at Full HD resolution
- WDR (Wide Dynamic Range) for extreme backlight applications
- Day/Night feature with removable IR cut filter for higher sensitivity and vibrant colors
- 0 Lux: Integrated IR LED illuminator for night-time operation
- 3 axis gimble allowing wall mounting
- Weatherproof outdoor casing (IP66)
- ONVIF Profile S



DIMENSIONS (MM)

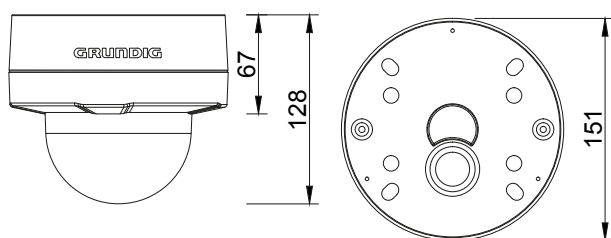

ACCESSORIES



SPECIFICATIONS

Image Sensor:	1/2.8" Sony Exmor™ CMOS
Pixels - Total:	1920(H) x 1080(V)
Digital Signal Processor (DSP):	Sony Xarina Solution
Sensitivity Colour:	0.01 Lux@F1.4 (IRE30), 0.05 Lux@F1.4 (IRE50)
Sensitivity B&W:	0.001 Lux@F1.4 (IRE30), 0.01 Lux@F1.4 (IRE50)
Col/B&W:	On/Off/Auto, IR-cut filter removable (ICR)
Lens Focal Length:	3 ~ 10.5 mm
Viewing Angle:	approx. 93°(w) ~ 32° (t)
Iris F-Number:	F= 1.4 ~ 360
Lens Drive Type:	Auto iris (DC)
Focus Adjustment:	Manual
IR LED:	24 pcs.
Max. IR Distance:	15/25 m (according to scene reflexion)
Wavelength:	850nm
Shutter Speed:	1 ~ 1/10.000 sec
WDR:	96 dB (Shutter WDR)
BLC: Back Light:	On/Off
White Balance:	AWB, Auto no boundary, ATW, Indoor, Outdoor, Manual
Digital Noise Reduction (DNR):	2DNR/3DNR: Off/Low/Mid/High
Digital Image Stabilization (DIS):	Off/On
D&N Switching Mode:	Light Sensor (Auto with LED), Light ON, Light OFF, SMART, Auto, Night, Day
Schedule:	Single Day or Week, Time (Start, Duration), DAY or NIGHT Mode
Alarm Event:	Enable Alarm Output, Send message by FTP or/and Email, Upload image by FTP or/and Email, Send HTTP notification, IR CUT filter switch On/Off, Record to Micro SD Card
Reverse:	Normal, Flip, Mirror, Vertical Mode, 180°
Privacy Zones/type:	5 / rectangle, Color selection
Video Compression:	H.264 (MPEG-4Part 10/AVC), MJPEG
ONVIF compliant:	Profile S
Video Streaming:	Single Stream, Dual Stream, Triple Stream, Quad stream
Video Resolution:	Full HD 1080p/ SXGA/ HD 720p/ XGA/SVGA/ 4CIF/ VGA/ CIF
Frame Rate (Max@Resolution):	50fps@2MP, 25fps@2MP, 50fps@1,3MP, 25fps@1,3MP, etc.
Audio:	G.726, G.711/ Bi-directional
Audio Input/Output:	Line In/Line Out (two way Audio)
Alarm I/O:	1 (5V, 10KΩ) / 1 (max.300VDC/AC, 39W)
Access protection:	By log-in and Password, IP filter, IEEE802.1x
Number of Clients:	Up to 20 simultaneously
Micro SDHC memory:	Supports up to 32GB
Recording Types:	on Micro SD/SDHC CARD, Single Image Recording (JPEG), Video (AVI)
Web Browser:	MS Internet Explorer 6.0 (or higher), Firefox, Google Chrome, Safari, Access over Mobile Devices
Network Protocol:	IPv4/v6, TCP/IP, UDP, RTP, RTSP, HTTP, HTTPS, DHCP, PPPoE, UPnP, SMTP, ICMP, IGMP, SNMP, IEEE802.1x, QoS, ONVIF, FTP, ARP
Input/Output Sockets:	Video Out(BNC), Power 4-Pin Terminal Block (2 Pin VDC, 2 Pin VAC), RJ-45, Micro SDHC Card Slot, Terminal 9 Pin(Alarm IN 2Pin, Alarm OUT 2Pin, Audio IN L/R 2 PIN, AUDIO OUT 2 PIN L/R, Audio GND 1 PIN)
Protection Rating:	IP66 / IK10
Operating Temperature:	-25°C ~ +55°C
Humidity:	10 ~ 90% no condensation
Standards:	CE, FCC, RoHS Compliant
Supply Voltage:	12 VDC / 24 VAC / PoE IEEE 802.3af
Power Consumption:	10 (LED ON) W
Weight:	1 kg
Dimensions (WxHxD):	Ø 151 x 128 mm



GCI-K1587V

**2 MP Full HD VF Dome IP-Camera 3~9mm
AFZ Modul/P-Iris ICR IR 24 LED WDR**

- EXMOR™ sensor for low light sensitivity
- XARINA™ DSP for advanced functionality
- 2 Megapixel IP camera with Full - HD, 1080P, real time video streaming
- High frame rate - 60 frames per second at Full HD resolution
- Tamron P-Iris Lens with Auto Focus Zoom Module
- WDR (Wide Dynamic Range) for extreme backlight applications
- Day/Night feature with removable IR cut filter for higher sensitivity and vibrant colors
- 0 Lux: Integrated IR LED Illuminator for night time operation
- 3 axis gimble allowing wall mounting
- Weatherproof outdoor casing (IP66)

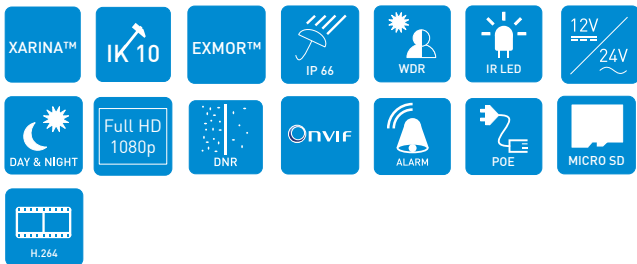

DIMENSIONS (MM)

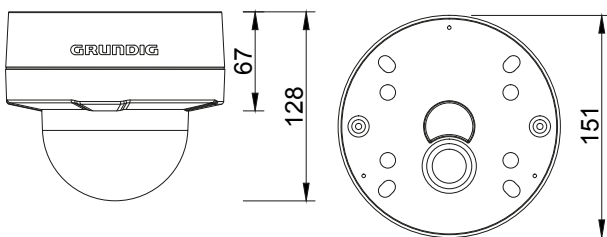

ACCESSORIES



SPECIFICATIONS

Image Sensor:	1/2.8" Sony Exmor™ CMOS
Pixels - Total:	1920(H) x 1080(V)
Digital Signal Processor (DSP):	Sony Xarina Solution
Sensitivity Colour:	0.01 Lux@F1.4 (IRE30), 0.05 Lux@F1.4 (IRE50)
Sensitivity B&W:	0.001 Lux@F1.4 (IRE30), 0.01 Lux@F1.4 (IRE50)
Col/B&W:	On/Off/Auto, IR-cut filter removable (ICR)
Lens Focal Length:	3 - 9 mm
Viewing Angle:	approx. 93°(w) - 32° (t)
Digital Zoom/ Iris F-Number:	Off/2 ~ 16x/ F= 1.2 ~ 3.60
Lens Drive Type:	Tamron® Auto-Focus-Zoom Module, P-Iris
Focus Adjustment:	AF / One-Shot AF / Manual
IR LED:	24 pcs.
Max. IR Distance:	15/25 m (according to scene reflexion)
Wavelength:	850nm
Shutter Speed/WDR:	1 ~ 1/10.000 sec/ 96dB (Shutter WDR)
BLC: Back Light:	On/Off
White Balance:	AWB, Auto no boundary, ATW, Indoor, Outdoor, Manual
Digital Noise Reduction (DNR):	2DNR/3DNR: Off/Low/Mid/High
Digital Image Stabilization (DIS):	Off/On
D&N Switching Mode:	Light Sensor (Auto with LED), Light ON, Light OFF, SMART, Auto, Night, Day
Schedule:	Single Day or Week, Time (Start, Duration), DAY or NIGHT Mode
Alarm Event:	Enable Alarm Output, Send message by FTP or/and Email, Upload image by FTP or/and Email, Send HTTP notification, IR CUT filter switch On/Off, Record to Micro SD Card
Reverse:	Normal, Flip, Mirror, Vertical Mode, 180°
Privacy Zones:	5/ rectangle
Network:	10/100 Base-T
Video Compression:	H.264 (MPEG-4Part 10/AVC), MJPEG
ONVIF compliant:	Profile S
Video Streaming:	Single Stream, Dual Stream, Triple Stream, Quad stream
Video Resolution:	Full HD 1080p/ SXGA/ HD 720p/ XGA/SVGA/ 4CIF/ VGA/ CIF
Frame Rate (Max@Resolution):	50fps@2MP, 25fps@2MP, 50fps@1,3MP, 25fps@1,3MP, etc.
Audio:	G.726, G.711/ Bi-directional
Audio I/O:	Line In/Line Out (two way Audio)
Alarm I/O:	1 (5V, 10KΩ) / 1 (max.300VDC/AC, 39W)
Access protection:	By log-in and Password, IP filter, IEEE802.1x
Number of Clients:	Up to 20 simultaneously
Micro SDHC memory:	Supports up to 32GB
Recording Types:	on Micro SD/SDHC CARD, Single Image Recording (JPEG), Video(AVI, LCK)
Network Protocol:	IPv4/v6, TCP/IP, UDP, RTP, RTSP, HTTP, HTTPS, DHCP, PPPoE, UPnP, SMTP, ICMP, IGMP, SNMP, IEEE802.1x, QoS, ONVIF, FTP, ARP
LED Indicator/ Video Outputs:	Power, link, active/ 1Vpp, BNC
Input/Output Sockets:	Video Out(BNC), Power 4-Pin Terminal Block (2 Pin VDC, 2 Pin VAC), RJ-45, Micro SDHC Card Slot, Terminal 9 Pin(Alarm IN 2Pin, Alarm OUT 2Pin, Audio IN L/R 2 PIN, AUDIO OUT 2 PIN L/R, Audio GND 1 PIN)
Protection Rating:	IP66 / IK10
Operating Temperature:	-25°C ~ +55°C
Humidity:	10 ~ 90% no condensation
Standards:	CE, FCC, RoHS Compliant
Supply Voltage:	12 VDC / 24 VAC / PoE IEEE 802.3af
Power Consumption:	13 (LED ON) W
Weight:	1 kg
Dimensions (WxHxD):	Ø 151 x 128 mm



GCI-F1576VH

3 MP Full HD VF Dome IP-Camera 3~9mm AFZ Modul/P-Iris ICR IR 24 LED

- 3 Megapixel IP camera with Full - HD, 1080P, real time video streaming
- Tamron P-Iris lens with Auto Focus Zoom module
- Day/Night feature with removable IR cut filter for higher sensitivity and vibrant colors
- Fan and heater included
- 0 Lux: Integrated IR LED illuminator for night-time operation
- 3 axis gimble allowing wall mounting
- Vandal-resistant and weather-proof
- ONVIF Profile S

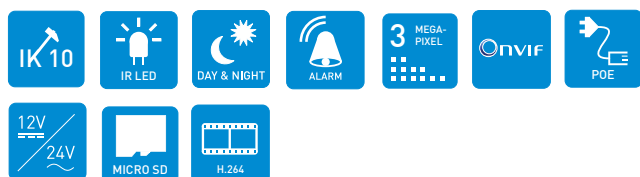

DIMENSIONS (MM)

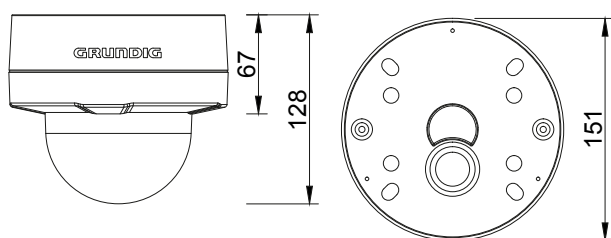

ACCESSORIES



SPECIFICATIONS

Image Sensor:	1/2.8" Sony Exmor™ CMOS, 3 Megapixels
Pixels - Total:	2048 (H) x 1536 (V)
Digital Signal Processor (DSP):	Ambarella A5S
Sensitivity Colour:	0.5 Lux@F1.2 (IRE50), 0.2 Lux@F1.2 (IRE30)
Sensitivity B&W:	0.1 Lux@F1.2 (IRE50), 0.02 Lux@ F1.2 (IRE30)
Col/B&W:	On/Off/Auto, IR-cut filter removable (ICR)
Lens Focal Length:	3 ~ 9 mm
Viewing Angle:	approx. 104°(H) ~ 33°(V)
Iris F-Number:	F= 1.2 ~ 360
Lens Drive Type:	Tamron® Auto-Focus-Zoom Module, P-Iris
Focus Adjustment:	Auto, Manual
IR LED:	24 pcs., 90° Beaming Angle
Max. IR Distance:	15/25 m (according to scene reflexion)
Wavelength:	850nm
Shutter Speed:	1 ~ 1/10.000 sec
WDR:	75dB (Digital Wide Dynamic Range) Off/Low/Middle/High
BLC: Back Light:	On/Off
White Balance:	ATW, AWB, Manual, Push
Digital Noise Reduction (DNR):	2DNR/3DNR: Off/Low/Mid/High
D&N Switching Mode:	Light Sensor (Auto with LED), Light ON, Light OFF, SMART, Auto, Night, Day
Audio detection:	Off, On
Schedule:	Single Day or Week, Time (Start, Duration), DAY or NIGHT Mode
Reverse:	Normal, Flip, Mirror, Vertical Mode (90°clockwise,90° counter clockwise), 180°
Privacy Zones:	5/ rectangle
Alarm Event:	Enable Alarm Output, Send message by FTP or/and Email, Upload image by FTP or/and Email, Send HTTP notification, IR CUT filter switch On/Off, Record Video Clip
Video Compression:	H.264 (MPEG-4Part 10/AVC), MJPEG
ONVIF compliant:	Profile S
Video Streaming:	Single Stream, Dual Stream, Triple Stream, Quad stream
Video Resolution:	3MP (2048x1536) / Full HD 1080p /SXGA / HD720p / XGA / SVGA / 4CIF/ VGA / CIF
Frame Rate (Max@Resolution):	15fps@3MP, 25fps@2MP, 25fps@1,3MP, etc.
Audio:	G.726, G.711 / Bi-directional
Audio Input/Output:	Line In/Line Out (two way Audio)
Alarm I/O:	1 (5V, 10KΩ) / 1 (max.300VDC/AC, 39W)
Access protection:	By log-in and Password, IP filter, IEEE802.1x
Number of Clients/ Micro SDHC memory:	Up to 20 simultaneously/ Supports up to 32GB
Recording Types:	on Micro SD/SDHC CARD: Single Image Recording (JPEG), Video(AVI, LCK) on NAS: Video (AVI)
Network Protocol:	IPv4/v6, TCP/IP, UDP, RTP, RTSP, HTTP, HTTPS, DHCP, PPPoE, UPnP, SMTP, ICMP, IGMP, SNMP, IEEE802.1x, QoS, ONVIF, FTP, ARP
LED Indicator/ Video Outputs:	Power, link, active/ 1Vpp, BNC
Input/Output Sockets:	Video Out(BNC), Power 4-Pin Terminal Block (2 Pin VDC, 2 Pin VAC), RJ-45, Micro SDHC Card Slot, Terminal 9 Pin(Alarm IN 2Pin, Alarm OUT 2Pin, Audio IN L/R 2 PIN, AUDIO OUT 2 PIN L/R, Audio GND 1 PIN
Protection Rating:	IP66 / IK10
Operating Temperature:	-40°C ~ +55°C
Humidity:	10 ~ 90% no condensation
Standards:	CE, FCC, RoHS Compliant
Supply Voltage:	12 VDC / 24 VAC / PoE IEEE 802.3at
Power Consumption:	20 (LED on) W
Weight:	0.8 kg
Dimensions (WxHxD):	Ø 151 x 128 mm



GCI-K1526T

2 MP Full HD Integrated IP-Camera 3~9mm

ICR IR 23 LED dWDR

- 2 Megapixel colour IP camera with real time, Full HD
- Day/Night feature with removable IR cut filter for higher sensitivity and vibrant colors
- 0 Lux: Integrated IR LED illuminator for night-time operation
- ONVIF Profile S
- Weatherproof outdoor casing (IP66)
- 3 axis gimble allowing wall mounting
- Power input AC24V/DC12V and PoE

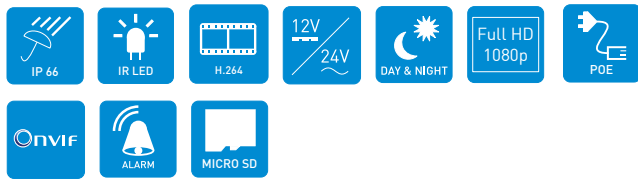

DIMENSIONS (MM)

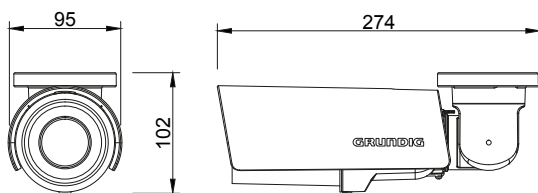

ACCESSORIES

GBR-PM02



SPECIFICATIONS

Image Sensor:	1/2.7" CMOS, 2 Megapixel
Pixels - Total:	1920(H) x 1080(V)
Digital Signal Processor (DSP):	Ambarella A55
Col/B&W:	On/Off/Auto, IR-cut filter removable (ICR)
Sensitivity Colour:	0.5 Lux@F1.4 (IRE50), 0.2 Lux@F1.4 (IRE30)
Sensitivity B&W:	0.1 Lux@F1.4 (IRE50), 0.02 Lux@ F1.4 (IRE30)
Lens Drive Type:	Auto iris (DC)
Lens Focal Length:	3 ~ 9 mm
Viewing Angle:	approx. 104°(H) ~ 33°(V)
IR LED:	23 pcs., 90° beaming angle
Max. IR Distance:	15/25 m (according to scene reflexion)
WDR:	D-WDR (Digital wide dynamic range)
BLC: Back Light:	On/Off
Digital Noise Reduction (DNR):	On/Off (Adaptive 3D + 2D)
Motion Detection:	On/ Off/ Sensitivity/ Area setting
Tampering Alarm:	On/Off
Privacy Zones:	5 zones, rectangle
White Balance:	ATW, AWB, Manual
Digital Zoom:	Off ~ 8x
Shutter Speed:	1 ~ 1/10.000 sec
Alarm Inputs:	1
Alarm Outputs:	1
Web Browser:	MS Internet Explorer 6.0 (or higher), Firefox, Google Chrome, Safari
Number of Clients:	Up to 20 simultaneously
Video Compression:	H.264 (MPEG4 Part 10/AVC), MJPEG
Video Resolution:	Full HD 1080p/ SXGA/ HD 720p/ XGA/SVGA/ 4CIF/ VGA/ CIF
Video Streaming:	Single Stream, Dual Stream, Triple Stream, Quad stream
Network Protocol:	IPv4/v6, TCP/IP, UDP, RTP, RTSP, HTTP, HTTPS, DHCP, PPPoE, UPnP, SMTP, ICMP, IGMP, SNMP, IEEE802.1x, QoS, ONVIF, ARP
SD Memory:	supports up to 32 GB capacity of micro SD/SDHC memory
Recording Types:	on Micro SD/SDHC CARD: Single Image Recording (JPEG), Video(AVI, LCK) on NAS: Video (AVI)
Alarm Event:	Image Transfer or Alarm Message by FTP, Image Transfer or Alarm Message by E-mail, Recording on SD-Card, enable Alarm Output and send HTTP Notification
Audio Compression:	G.726, G.711
Video Outputs:	1Vpp, BNC
Input/Output Sockets:	Video Out(BNC), Power(3-Pin Term), RJ-45, Micro SDHC Card Slot, Alarm Terminal 4-Pin (Alarm In 2-Pin, Alarm Out 2-Pin), Audio (2 mini Jack 3.5mm)
Protection Rating:	IP 66
Operating Temperature:	-25°C ~ +55°C
Humidity:	10 ~ 90% no condensation
Standards:	CE, FCC, RoHS Compliant
Supply Voltage:	12 VDC / 24 VAC / PoE IEEE 802.3af
Power Consumption:	8.9 (LED on) W
Weight:	1.1 kg
Dimensions (WxHxD):	Ø 95 x 102 x 274 mm



GCI-K1526TH

2 MP Full HD Integrated IP-Camera 3~9mm ICR IR 23 LED dWDR w/ Heater

- 2 Megapixel colour IP camera with real time, Full HD 1080P video streams
- Fan and heater included
- Day/Night feature with removable IR cut filter for higher sensitivity and vibrant colors
- 0 Lux: Integrated IR LED illuminator for night-time operation
- ONVIF Profile S
- Weatherproof outdoor casing (IP66)
- 3 axis gimble allowing wall mounting
- Power input AC24V/DC12V and PoE

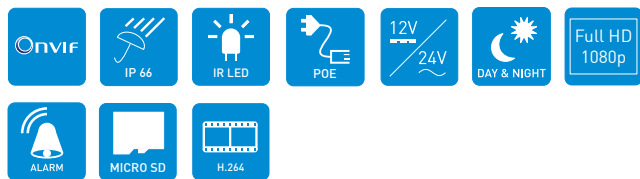

DIMENSIONS (MM)

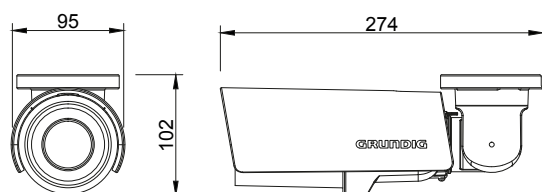

ACCESSORIES

GBR-PM02



SPECIFICATIONS

Image Sensor:	1/2.7" CMOS, 2 Megapixel
Pixels - Total:	1920[H] x 1080[V]
Digital Signal Processor (DSP):	Ambarella A5S
Col/B&W:	On/Off/Auto, IR-cut filter removable (ICR)
Sensitivity Colour:	0.5 Lux@F1.4 (IRE50), 0.2 Lux@F1.4 (IRE30)
Sensitivity B&W:	0.1 Lux@F1.4 (IRE50), 0.02 Lux@ F1.4 (IRE30)
Lens Drive Type:	Auto iris (DC)
Lens Focal Length:	3 ~ 9 mm
Viewing Angle:	approx. 104°(H) ~ 33°(V)
IR LED:	23 pcs., 90° beaming angle
Max. IR Distance:	15/25 m (according to scene reflexion)
WDR:	D-WDR (Digital wide dynamic range)
BLC: Back Light:	On/Off
Digital Noise Reduction (DNR):	On/Off (Adaptive 3D + 2D)
Motion Detection:	On/ Off/ Sensitivity/ Area setting
Tampering Alarm:	On/Off
Privacy Zones:	5 zones, rectangle
White Balance:	ATW, AWB, Manual
Digital Zoom:	Off ~ 8x
Shutter Speed:	1 ~ 1/10.000 sec
Alarm I/O:	1 (5V, 10KΩ) / 1 (max.300VDC/AC, 39W)
Web Browser:	MS Internet Explorer 6.0 (or higher), Firefox, Google Chrome, Safari
Number of Clients:	Up to 20 simultaneously
Video Compression:	H.264 (MPEG4 Part 10/AVC), MJPEG
Video Resolution:	Full HD 1080p/ SXGA/ HD 720p/ XGA/SVGA/ 4CIF/ VGA/ CIF
Video Streaming:	Single Stream, Dual Stream, Triple Stream, Quad stream
Network Protocol:	IPv4/v6, TCP/IP, UDP, RTP, RTSP, HTTP, HTTPS, DHCP, PPPoE, UPnP, SMTp, ICMP, IGMP, SNMP, IEEE802.1x, QoS, ONVIF, ARP
SD Memory:	supports up to 32 GB capacity of micro SD/SDHC memory
Recording Types:	on Micro SD/SDHC CARD: Single Image Recording (JPEG), Video(AVI, LCK) on NAS: Video (AVI)
Alarm Event:	Image Transfer or Alarm Message by FTP, Image Transfer or Alarm Message by E-mail, Recording on SD-Card, enable Alarm Output and send HTTP Notification
Audio Compression:	G.726, G.711
Video Outputs:	1Vpp, BNC
Input/Output Sockets:	Video Out(BNC), Power(3-Pin Term), RJ-45, Micro SDHC Card Slot, Alarm Terminal 4-Pin (Alarm In 2-Pin, Alarm Out 2-Pin), Audio (2 mini Jack 3.5mm)
Protection Rating:	IP 66
Operating Temperature:	power by 12VDC: -30°C ~ +55°C, power by 24VAC: -35°C ~ +55°C, power by PoE: -25°C ~ +55°C
Humidity:	10 ~ 90% no condensation
Standards:	CE, FCC, RoHS Compliant
Supply Voltage:	12 VDC / 24 VAC / PoE IEEE 802.3af
Power Consumption:	18 (Heater/LED on) W
Weight:	1 kg
Dimensions (WxHxD).	Ø 95 x 102 x 274 mm



GCI-K0589T-1

2 MP Full HD Integrated IP-Camera 3~9mm P-Iris

AFZ Modul ICR IR 23LED dWDR

- 2 Megapixel IP camera with Full HD 1080 real time videostream
- Tamron P-Iris Lens with Auto Focus Zoom Module
- Day/Night feature with removable IR cut filter for higher sensitivity and vibrant colors
- 0 Lux: Integrated IR LED illuminator for night-time operation
- ONVIF Profile S
- Weatherproof outdoor casing (IP66)
- 3 axis gimble allowing wall mounting
- Power input AC24V/DC12V and PoE

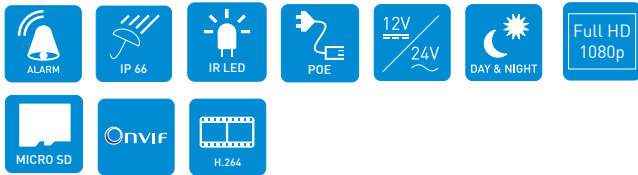

DIMENSIONS (MM)

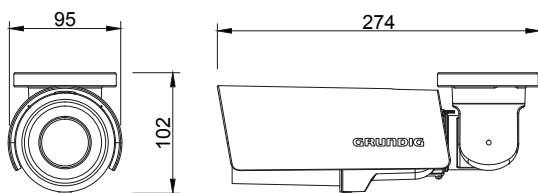

ACCESSORIES

GBR-PM02



SPECIFICATIONS

Image Sensor:	1/2.7" CMOS, 2 Megapixel
Pixels - Total:	1920(H) x 1080(V)
Digital Signal Processor (DSP):	Ambarella A5S
Col/B&W:	On/Off/Auto, IR-cut filter removable (ICR)
Sensitivity Colour:	0.5 Lux@F1.2 (IRE50), 0.2 Lux@F1.2 (IRE30)
Sensitivity B&W:	0.1 Lux@F1.2 (IRE50), 0.02 Lux@ F1.2 (IRE30)
Focal Length:	3 ~ 9 mm
Viewing Angle:	108°(W) ~ 41°(T)
Lens Drive Type:	Tamron® Auto-Focus-Zoom Module, P-Iris
Focus Adjustment:	AF / One-Shot AF / Manual
Shutter Speed:	1 ~ 1/10.000 sec
IR LED:	23 pcs., 90° beaming angle
Max. IR Distance:	15/25 m (according to scene reflexion)
AGC:	Auto, Manual
BLC: Back Light:	On/Off
White Balance:	ATW, Manual
Privacy Zones:	5 zones, rectangle
Motion Detection:	On/ Off/ Sensitivity/ Area setting
Tampering Alarm:	On/Off
Digital Noise Reduction (DNR):	On/off 2D/3D Noise Filter
Reverse:	Normal, Flip, Mirror, Vertical Mode [90°clockwise, 90° counter clockwise], 180°
OSD:	Yes, multi language
Alarm Event:	Alarm Input, Motion Detection, Tampering: Alarm Out by http, FTP, E-mail, recording on Micro SD-card
Alarm Input/Output:	1/1
SD Memory:	supports up to 32 GB capacity of micro SD/SDHC memory on Micro SD/SDHC CARD:
Recording Types:	Single Image Recording (JPEG), Video(AVI, LCK) on NAS: Video (AVI)
Input/Output Sockets:	Video Out(BNC), Power(3-Pin Term), RJ-45, Micro SDHC Card Slot, Alarm Terminal 4-Pin (Alarm In 2-Pin, Alarm Out 2-Pin), Audio [2 mini Jack 3.5mm]
Video Outputs:	1 CVBS (1Vpp), BNC
Web Browser:	MS Internet Explorer 6.0 (or higher), Firefox, Google Chrome, Safari
Access protection:	By log-in and Password, IP filter, IEEE802.1x
Number of Clients:	Up to 20 simultaneously
Video Compression:	H.264 (MPEG4 Part 10/AVC), MJPEG
Video Streaming:	Single Stream, Dual Stream, Triple Stream, Quad stream
Video Resolution:	Full HD 1080p/ SXGA/ HD 720p/ XGA/SVGA/ 4CIF/ VGA/ CIF
Network Protocol:	IPv4/v6, TCP/IP, UDP, RTP, RTSP, HTTP, HTTPS, DHCP, PPPoE, UPnP, SMTP, ICMP, IGMP, SNMP, IEEE802.1x, QoS, ONVIF, FTP
Audio:	G.726, G.711, Bi-directional
ONVIF compliant:	Profile S
Protection Rating:	IP 66
Operating Temperature:	-25°C ~ +55°C
Humidity:	10 ~ 90% no condensation
Standards:	CE, FCC, RoHS Compliant
Supply Voltage:	12 VDC / 24 VAC / PoE IEEE 802.3af
Power Consumption:	12 W
Weight:	1 kg
Dimensions (WxHxD):	Ø 95 x 102 x 274 mm



GCI-F0576TH

3 MP Full HD Integrated IP-Cam 3~9mm AFZ Modul/ P-Iris ICR IR 24 LED

- 3 Megapixel IP camera with Full - HD 1080P real time video streaming
- Tamron P-Iris lens with Auto Focus Zoom module
- Day/Night feature with removable IR cut filter for higher sensitivity and vibrant colors
- 0 Lux: Integrated IR LED illuminator for night-time operation
- ONVIF Profile S
- Weatherproof outdoor casing (IP66)
- Bidirectional audio support
- 3 axis gimble allowing wall mounting

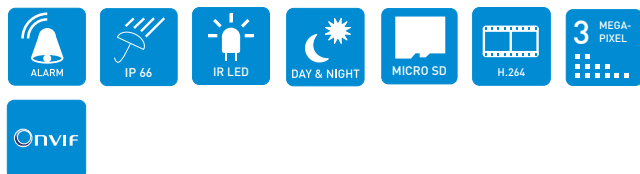

DIMENSIONS (MM)

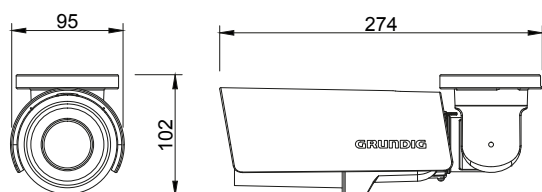

ACCESSORIES

GBR-PM02



SPECIFICATIONS

Image Sensor:	1/2.8" Sony Exmor™ CMOS, 3 Megapixels
Pixels - Total:	2048 (H) x 1536 (V)
Digital Signal Processor (DSP):	Ambarella A5S
Sensitivity Colour:	0.2 lux @ F1.2
Sensitivity B&W:	0.02 lux @ F1.2
Col/B&W:	On/Off/Auto, IR-cut filter removable (ICR)
Focal Length:	3 ~ 9 mm
Viewing Angle:	approx. 100°(w) ~ 35°(t)
Iris F-Number:	F= 1.2 ~ 360
Lens Drive Type:	Tamron® Auto-Focus-Zoom Module, P-Iris
Focus Adjustment:	Auto, Manual
IR LED:	24 pcs., 90° Beaming Angle
Max. IR Distance:	15/25 m (according to scene reflexion)
Wavelength:	850nm
Shutter Speed:	1 ~ 1/10.000 sec
WDR:	75dB (Digital Wide Dynamic Range) Off/Low/Middle/High
BLC (Back Light)/ White Balance:	On,Off/ ATW, AWB, Manual, Push
Digital Noise Reduction (DNR):	On/off 2D/3D Noise Filter
D&N Switching Mode:	Light Sensor (Auto with LED), Light ON, Light OFF, SMART, Auto, Night, Day
Schedule:	Single Day or Week, Time (Start, Duration), DAY or NIGHT Mode
Reverse:	Normal, Flip, Mirror, Vertical Mode (90°clockwise, 90° counter clockwise), 180°
Privacy Zones:	5, rectangle
Alarm Event:	Image transfer or alarm message by FTP, Image transfer or alarm message by E-mail, recording on SD-card and enable alarm output
Video Compression:	H.264 (MPEG-4Part 10/AVC), MJPEG
ONVIF compliant:	Profile S
Video Streaming:	Single Stream, Dual Stream, Triple Stream, Quad stream
Video Resolution:	3MP(2048x1536)/Full HD 1080p/SXGA/HD 720p/XGA/SVGA/4CIF/VGA/CIF
Frame Rate (Max@Resolution):	15fps@3MP, 25fps@2MP, 25fps@1,3MP, etc.
Audio:	G.726, G.711, Bi-directional
Audio Input/Output:	Line In/Line Out (two way Audio)
Alarm I/O:	1 (5V, 10KΩ) / 1 (max.300VDC/AC, 39W)
Access protection:	By log-in and Password, IP filter, IEEE802.1x
Number of Clients:	Up to 20 simultaneously
SD Memory:	supports up to 32 GB capacity of micro SD/SDHC memory
Recording Types:	on Micro SD/SDHC CARD: Single Image Recording (JPEG), Video(AVI, LCK) on NAS: Video (AVI)
Web Browser:	MS Internet Explorer 6.0 (or higher), Firefox, Google, Chrome, Safari, Access over Mobile Devices
Network Protocol:	IPv4/v6, TCP/IP, UDP, RTP, RTSP, HTTP, HTTPS, DHCP, PPPoE, UPnP, SMTp, ICMP, IGMP, SNMP, IEEE802.1x, QoS, ONVIF, FTP, ARP
Input/Output Sockets:	Video Out(BNC), Power(3-Pin Term), RJ-45, Micro SDHC Card Slot, Alarm, Terminal 4-Pin (Alarm In 2-Pin, Alarm Out 2-Pin), Audio (2 mini Jack 3.5mm)
Protection Rating:	IP 66
Operating Temperature:	-40°C ~ +55°C
Humidity:	10 ~ 90% no condensation
Standards:	CE, FCC, RoHS Compliant
Supply Voltage:	24VAC/ PoE IEEE802.3at
Power Consumption:	max. 24 W
Weight:	1 kg
Dimensions (WxHxD):	Ø 95 x 102 x 274 mm



GCI-K1577TH

2 MP Full HD Integrated IP-Camera 3~8mm Mzoom ICR IR 24 LED WDR

- EXMOR™ sensor for low light sensitivity
- XARINA™ DSP for advanced functionality
- 2 Megapixel IP camera with Full HD 1080 real time videostream
- Ultra low light camera for noise-free images
- Day/Night feature with removable IR cut filter for higher sensitivity and vibrant colors
- WDR (Wide Dynamic Range) for extreme backlight applications
- ONVIF Profile S
- Weatherproof outdoor casing (IP66)
- 3 axis gimble allowing wall mounting

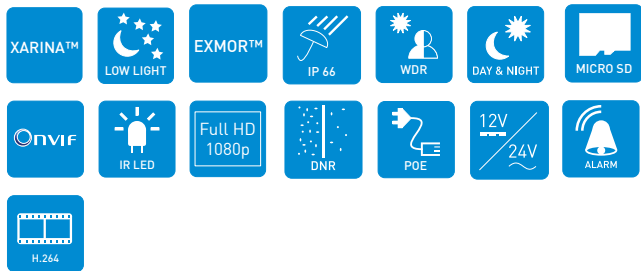

DIMENSIONS (MM)

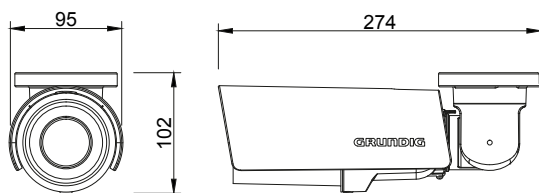

ACCESSORIES

GBR-PM02



SPECIFICATIONS

Image Sensor:	1/1.9" ExmorRS™ Sensor
Pixels - Total:	1920(H) x 1080(V)
Digital Signal Processor (DSP):	Sony Xarina Solution
Sensitivity Colour:	0.01 Lux@F1.5(IRE30), 0.05 Lux@F1.5(IRE50)
Sensitivity B&W:	0.0005 Lux@F1.5 (IRE30), 0.005 Lux@ F1.5 (IRE50)
Col/B&W:	On/Off/Auto, IR-cut filter removable (ICR)
Lens Focal Length/ Drive Type:	3.3 ~ 8 mm/ Motorized Zoom & Focus
Viewing Angle:	approx. 104°(W) ~ 33°(T)
Iris F-Number:	F= 1.5 ~ 360
Drive type:	Auto iris (DC)
Focus Adjustment:	Auto, Manual
IR LED/ Max. IR Distance:	24 pcs./ 25 m
Wavelength:	850nm
Shutter Speed:	1 ~ 1/10.000 sec
WDR:	96dB (Shutter WDR)
BLC: Back Light:	On/Off
White Balance:	AWB, Auto no boundary,ATW, Indoor, Outdoor, Manual
Privacy Zones:	5, rectangle
Schedule:	Single Day or Week, Time (Start, Duration), DAY or NIGHT Mode
Reverse:	Normal, Flip, Mirror, Vertical Mode, 180°
Digital Noise Reduction (DNR):	2DNR/3DNR: Off/Low/Mid/High
D&N Switching Mode:	Light Sensor (Auto with LED), Light ON, Light OFF, SMART, Auto, Night, Day
Alarm Event:	Enable Alarm Output, Send message by FTP or/and Email, Upload image by FTP or/and Email, Send HTTP notification, IR CUT filter switch On/Off, Record to Micro SD Card
Access protection:	By log-in and Password, IP filter, IEEE802.1x
Number of Clients:	Up to 20 simultaneously
Video Compression:	H.264 (MPEG-4Part 10/AVC), MJPEG
ONVIF compliant:	Profile S
Video Streaming:	Single Stream, Dual Stream, Triple Stream, Quad stream
Video Resolution:	Full HD 1080p/ SXGA/ HD 720p/ XGA/SVGA/ 4CIF/ VGA/ CIF
Frame Rate (Max@Resolution):	50fps@2MP, 25fps@2MP, 50fps@1.3MP, 25fps@1.3MP, etc.
Network Protocol:	IPv4/v6, TCP/IP, UDP, RTP, RTSP, HTTP, HTTPS, DHCP, PPPoE, UPnP, SMTP, ICMP, IGMP, SNMP, IEEE802.1x, QoS, ONVIF, FTP, ARP
Audio:	G.726, G.711/ Bi-directional
Multi Language Webpage:	English, German, French, Italian, Russian, Turkish
Audio Input/Output:	Line In/Line Out (two way Audio)
Alarm I/O:	1 (5V, 10KΩ) / 1 (max.300VDC/AC, 39W)
Micro SDHC memory:	Supports up to 64GB
Recording Types:	on Micro SD/SDHC CARD, Single Image Recording (JPEG) Video (AVI)
Web Browser:	MS Internet Explorer 6.0 (or higher), Firefox, Google Chrome, Safari, Access over Mobile Devices
Input/Output Sockets:	Power(Terminal 3-Pin), RJ-45, Micro SD Card Slot, Alarm Terminal 4-Pin(Alarm In 2-Pin, Alarm Out 2-Pin), Audio IN Stereo phone jack Ø3,5mm, Audio Out Stereo phone jack Ø3,5mm
Protection Rating:	IP 66
Operating Temperature:	-40°C ~ +50°C
Humidity:	10 ~ 90% no condensation
Standards:	CE, FCC, RoHS Compliant
Supply Voltage:	24VAC/ PoE IEEE802.3at
Power Consumption:	max. 16.5 W
Weight:	1 kg
Dimensions (WxHxD):	Ø 95 x 102 x 274 mm



GCI-C0745P-1

D1 Outdoor Motorized Dome IP-Camera 36x Zoom ICR WDR

- Full D1, Day/Night speed dome camera (720x576)
- Day/Night camera with removable IR cut filter and WDR
- 36x motorized optical zoom with 12x digital zoom
- Vandal-resistant and weather-proof
- High speed Pan/Tilt (400°/sec) minimum speed (0.5°/sec)
- ONVIF Profile S

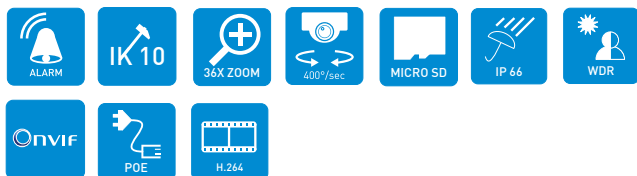

DIMENSIONS (MM)

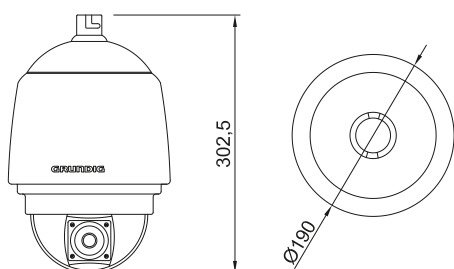

SPECIFICATIONS

Image Sensor:	1/4" CCD (Super HAD II)
Pixels - Total:	976x582 (570k)
Digital Signal Processor (DSP):	Sony EFFIO DSP solution
Zoom Ratio:	x 36
Focal Length:	3.4 ~ 122.4 mm
Viewing Angle:	60.08° ~ 1.8°
Aperture Ratio:	F1.6 ±5%(Wide) ~ F4.5 ±5%(Tele)
Lens Drive Type:	Auto Iris
S/N Ratio:	50 dB
BLC: Back Light:	On/Off + WDR
White Balance:	Auto / Manual
Camera ID:	20 character
Co/B&W:	On/Off/Auto, IR-cut filter removable (ICR)
Alarm I/O:	4 / 1
Video Compression:	H.264 (MPEG4 Part 10/AVC), MJPEG
Network Protocol:	IPv4, IPv6, TCP/IP, UDP, RTP, RTSP, HTTP, HTTPS, ICMP, FTP, SMTP, DHCP, PPPoE, UPnP, IGMP, 802.1X and SNMP
Alarm Event:	Image transfer or alarm message by FTP, Image transfer or alarm message by E-mail, recording on , SD-card and enable alarm output
Audio Compression:	G.726, G.711
Shutter Speed:	1 ~ 1/10.000 sec
Video Streaming:	Single Stream, Dual Stream, Triple Stream, Quad stream
Video Resolution:	D1 (720x576), VGA (640x480), CIF (352x288)
Frame Rate (Max@Resolution):	max.: 50fps@D1 720x576, 50fps@VGA 640x480, 50fps@CIF 352x288
Resolution:	650 (H) lines
Web Browser:	MS Internet Explorer 6.0 (or higher), Firefox, Google Chrome, Safari
Sensitivity:	0.1 lux (Colour) / 0.01 lux (B&W)
SD Memory:	supports up to 32 GB capacity of micro SD/SDHC memory
Standards:	CE, FCC, RoHS Compliant
Number of Privacy Zones:	16
Pan Speed:	Manual: 0.5°/s ~ 90°/s, Preset: 400°/s (max.)
Tilt Speed:	Manual: 0.5°/s ~ 90°/s, Preset: 400°/s (max.)
Range Panning:	360° endless
Range Tilting:	-10° ~ 190°
Number of Preset:	256
Digital Image Stabilization (DIS):	Off/On
Sequence:	8
Protection Rating:	IP66 / IK10
Operating Temperature:	-40°C ~ +50°C
Supply Voltage:	24 VAC / hPoE (60W)
Power Consumption:	60 W
Weight:	2.6 kg
Dimensions (WxHxD):	Ø 190 X 303 mm

ACCESSORIES

GBR-WA02



GBR-CM01



GBR-PM01



GBR-CE01



GBR-AM02



GAC-B0502A





GCI-K0779P

2 MP Full HD Indoor Motorized Dome IP-Camera 18x Zoom ICR dWDR

- 2 Megapixel IP camera with Full - HD 1080P real time video streaming
- Day/Night feature with removable IR cut filter for higher sensitivity and vibrant colors
- 18x motorized optical zoom
- High speed pan/tilt (400°/sec) minimum speed (0.5°/sec)
- ONVIF Profile S



DIMENSIONS (MM)

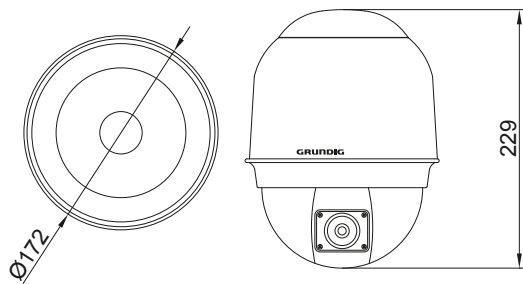

ACCESSORIES

GBR-IC05



GBR-AM03



GBR-WA02



GBR-CM01



GBR-PM01



GBR-CE01



GBR-AM02



GAC-B0502A



SPECIFICATIONS

Image Sensor:	1/2.8" CMOS
Pixels - Total:	1920(H) x 1080(V)
Digital Signal Processor (DSP):	Ambarella A5S
Col/B&W:	On/Off/Auto, IR-cut filter removable (ICR)
Sensitivity Colour:	0.05 Lux@F1.6 (IRE50)
Sensitivity B&W:	0.001 Lux@F1.6 (IRE50)
BLC: Back Light:	On/Off
White Balance:	Auto, Manual, Indoor, Outdoor, ATW
Number of Privacy Zones:	16
Pan Speed:	Manual: 0.5°/s ~ 90°/s, Preset: 400°/s (max.)
Tilt Speed:	Manual: 0.5°/s ~ 90°/s, Preset: 400°/s (max.)
Range Panning:	360° endless
Range Tilting:	-10° ~ 190°
Number of Preset:	256
Number of Pattern:	8
Lens Drive Type:	Auto Iris
Focal Length:	4.7 ~ 84.6 mm
Viewing Angle:	H: 55.2° (Wide) ~ 3.2° (Tele)
Zoom Ratio:	x 18
OSD:	Yes
Alarm I/O:	4 / 2
Web Browser:	MS Internet Explorer 6.0 (or higher), Firefox, Google Chrome, Safari
Video Compression:	H.264 (MPEG4 Part 10/AVC), MJPEG
ONVIF compliant:	Profile S
Video Resolution:	Full HD 1080p, SXGA, 1280 x 720p, XGA, SVGA, 4CIF, VGA, CIF
Network Protocol:	IPv4/v6, TCP/IP, UDP, RTP, RTSP, HTTP, HTTPS, DHCP, PPPoE, UPnP, SMTP, ICMP, IGMP, SNMP, IEEE802.1x, QoS, ONVIF, FTP
SD Memory:	supports up to 32 GB capacity of micro SD/SDHC memory
Recording Types:	on Micro SD/SDHC CARD.: Single Image Recording (JPEG), Video(AVI, LCK) , on NAS: Video (AVI)
Alarm Event:	Enable Alarm Output1/Output2, Send message by FTP or/and Email, Upload image by FTP or/and Email, PTZ Function, Send HTTP notification,
Audio Compression:	G.726, G.711
Operating Temperature:	0°C ~ +40°C
Standards:	CE, FCC, RoHS Compliant
Supply Voltage:	24 VAC / hPoE (60W)
Power Consumption:	20 W
Weight:	1.62 kg
Dimensions (WxHxD):	Ø 172 X 229 mm



GCI-K1779P

2 MP Full HD Outdoor Motorized Dome IP-Camera 18x Zoom ICR WDR

- 2 Megapixel IP camera with Full - HD 1080P real time video streaming
- Day/Night feature with removable IR cut filter for higher sensitivity and vibrant colors
- 18x motorized optical zoom
- High speed pan/tilt (400°/sec) minimum speed (0.5°/sec)
- ONVIF Profile S



DIMENSIONS (MM)

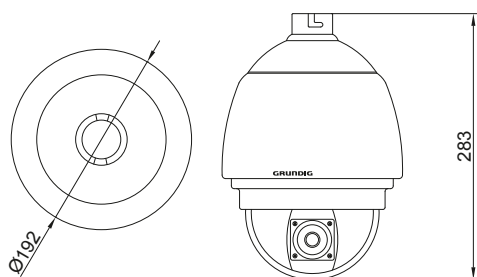

SPECIFICATIONS

Image Sensor:	1/2.8" CMOS
Digital Signal Processor (DSP):	Ambarella A55
Col/B&W:	On/Off/Auto, IR-cut filter removable (ICR)
Pixels - Total:	1920(H) x 1080(V)
Sensitivity Colour:	0.05 Lux@F1.6 (IRE50)
Sensitivity B&W:	0.001 Lux@F1.6 (IRE50)
BLC: Back Light:	On/Off
White Balance:	Auto, Manual, Indoor, Outdoor, ATW
Number of Privacy Zones:	16
Pan Speed:	Manual: 0.5°/s ~ 90°/s, Preset: 400°/s (max.)
Tilt Speed:	Manual: 0.5°/s ~ 90°/s, Preset: 400°/s (max.)
Range Panning:	360° endless
Range Tilting:	-10° ~ 190°
Number of Preset:	256
Number of Pattern:	8
Lens Drive Type:	Auto Iris
Focal Length:	4.7 ~ 84.6 mm
Viewing Angle:	H: 55.2° (Wide) ~ 3.2° (Tele)
Zoom Ratio:	x 18
Digital Zoom:	Off/1 ~ 10x
OSD:	Yes
Alarm I/O:	4 / 2
Web Browser:	MS Internet Explorer 6.0 (or higher), Firefox, Google Chrome, Safari
Video Compression:	H.264 (MPEG4 Part 10/AVC), MJPEG
ONVIF compliant:	Profile S
Video Streaming:	Single Stream, Dual Stream, Triple Stream, Quad stream
Video Resolution:	Full HP 1080p, SXGA, 1280 x 720p, XGA, SVGA, 4CIF, VGA, CIF
Network Protocol:	IPv4/v6, TCP/IP, UDP, RTP, RTSP, HTTP, HTTPS, DHCP, PPPoE, UPnP, SMTP, ICMP, IGMP, SNMP, IEEE802.1x, QoS, ONVIF, FTP
SD Memory:	supports up to 32 GB capacity of micro SD/SDHC memory on Micro SD/SDHC CARD.; Single Image Recording (JPEG), Video(AVI, LCK) , on NAS: Video (AVI)
Recording Types:	Enable Alarm Output1/Output2, Send message by FTP or/and Email, Upload image by FTP or/and Email, PTZ Function, Send HTTP notification,
Alarm Event:	
Audio Compression:	G.726, G.711
Operating Temperature:	0°C ~ +40°C
Standards:	CE, FCC, RoHS Compliant
Supply Voltage:	24 VAC / hPoE (60W)
Power Consumption:	20 W
Weight:	1.62 kg
Dimensions (WxHxD):	Ø 192 X 283 mm

ACCESSORIES

GBR-WA02



GBR-CM01



GBR-PM01



GBR-CE01



GBR-AM02



GAC-B0502A



GPC-B0701A





GCI-K2795P

2 MP Full HD Outdoor Motorized Dome IP-Camera 30x Zoom ICR WDR

- 2 Megapixel IP camera with Full - HD 1080P real time video streaming
- Day/Night feature with removable IR cut filter for higher sensitivity and vibrant colors
- Vandal resistant speed dome (IK10)
- High speed pan/tilt (400°/sec) minimum speed (0.5°/sec)
- 30x motorized optical zoom with 12x digital Zoom
- Weatherproof outdoor casing (IP66)
- ONVIF Profile S



DIMENSIONS (MM)

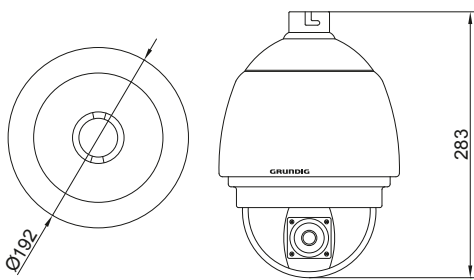

ACCESSORIES



SPECIFICATIONS

Image Sensor:	1/2.8" Sony Exmor™ CMOS
Pixels - Total:	1920(H) x 1080(V)
Digital Signal Processor (DSP):	Ambarella A5S
Sensitivity Colour:	0.05 Lux@F1.6 (IRE50)
Sensitivity B&W:	0.095 Lux @ F1.6 (IRE50)
Focal Length:	4.3 ~ 129 mm
Viewing Angle:	65.5°(Tele)/3.18°(Wide)
Zoom Ratio:	x 30
Lens Drive Type/ Iris F-Number:	DC auto iris / F= 1.6 ~ 360
Col/B&W:	On/Off/Auto, IR-cut filter removable (ICR)
AGC/WDR:	Auto, Manual/≥96dB
White Balance:	Auto, Manual, Indoor, Outdoor, ATW
Motion Detection:	On/ Off/ Sensitivity/ 10 Area setting/ by schedule
Digital Noise Reduction (DNR):	2DNR/3DNR (Off/On)
Alarm Event:	Image transfer or alarm message by FTP, Image transfer or alarm message by E-mail, recording on , SD-card and enable alarm output
Alarm I/O:	4/2
Recording Types:	on Micro SD/SDHC CARD , Single Image Recording (JPEG), Video(AVI, LCK)
Input/Output Sockets:	Power (Terminal 3-Pin), RJ-45, Micro SD Card Slot, Alarm Terminal (12-Pin Alarm IN/5-Pin, Alarm OUT/7-Pin), Audio IN/ OUT (3-Pin Terminal)
Number of Clients:	Up to 20 user, 1 x Admin
Video Compression:	H.264 (MPEG-4Part 10/AVC), MJPEG
Video Streaming:	Single Stream, Dual Stream, Triple Stream, Quad stream
ONVIF compliant:	Profile S
Video Resolution:	Full HD 1080p, SXGA, 1280 x 720p, XGA, SVGA, 4CIF, VGA, CIF
Network Protocol:	IPv4/v6, TCP/IP, UDP, RTP, RTSP, HTTP, HTTPS, DHCP, PPPoE, UPnP, SMTP, ICMP, IGMP, SNMP, IEEE802.1x, QoS, ONVIF, ARP
Audio Compression:	G.711/G.726
Shutter Speed:	1 ~ 1/10.000 sec
Audio Communication:	Bi-directional
Access protection:	By log-in and Password, IP filter, IEEE802.1x
Web Browser:	MS Internet Explorer 6.0 (or higher), Firefox, Google Chrome, Safari
SD Memory:	supports up to 32 GB capacity of micro SD/SDHC memory
Number of Privacy Zones:	16
Pan Speed:	Manual: 0.5°/s ~ 90°/s, Preset: 400°/s (max.)
Tilt Speed:	Manual: 0.5°/s ~ 90°/s, Preset: 400°/s (max.)
Range Panning:	360° endless
Auto Flip:	Image/Mechanic/Off
Range Tilting:	-10° ~ 190°
Number of Preset:	256
Digital Image Stabilization (DIS):	Off/On
Number of Pattern:	8
Preset Accuracy:	0.225°
Number of Auto PAN:	4
Protection Rating:	IP66 / IK10
Number of Cruise:	8
Home position:	Preset/Sequence/Auto Pan/Cruise
Operating Temperature:	-40°C ~ +50°C
Standards:	CE, FCC, RoHS Compliant, IP66
Supply Voltage:	24VAC/PoE(IEEE 802.3at 60W)
Power Consumption:	60 W
Weight:	2.32 kg
Dimensions (WxHxD):	Ø192 x 283 mm



IP RECORDERS

The standalone H.264 NVR range from Grundig has an embedded Linux operating system. Full HD, 1080P, 25FPS video in record and playback modes are available on each channel. Auto-configuration of Grundig IP cameras simplifies installation and its graphic user interface ensures intuitive operation.

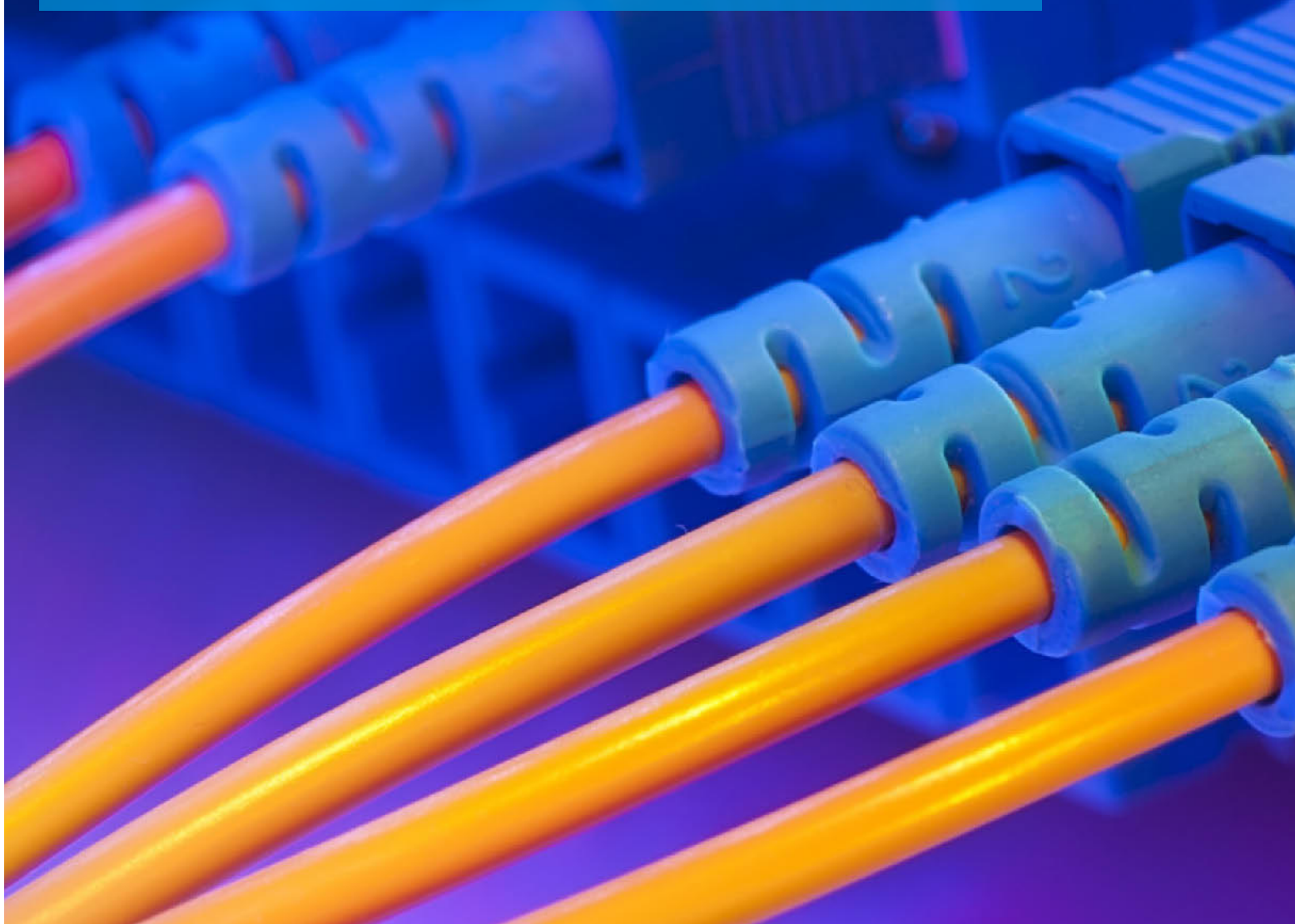



OVERVIEW IP RECORDERS

IP RECORDERS

MODEL	PICTURE	CHANNELS	RECORDING RESOLUTION	RECORDING SPEED	SATA	eSATA	USB	VIDEO OUT	AUDIO IN	ALARM IN	ALARM OUT	PAGE
GRI-K1104A		4	max. Full HD (1920x1080)	100 fps (1920x1080)	2	1	2	1x HDMI	4 Ch over IP	4 Ch. over IP + 2x N/O or N/C	1 relay	43
GRI-K2208A		8	max. Full HD (1920x1080)	200 fps (1920x1080)	2	1	2	1x HDMI	8 Ch over IP	8 Ch. over IP + 2x N/O or N/C	1 relay	44
GRI-K4416A		16	max. Full HD (1920x1080)	400 fps (1920 x1080)	5	1	3	1x HDMI, 1x VGA	16 Ch over IP	16 Ch. over IP + 2x N/O or N/C	1 relay	45



GRI-K1104A

4-Ch Full HD Standalone H.264 NVR

- High performance NVR with Full HD real-time recording
- Easy to use user interface
- Auto-configuration for Grundig IP cameras
- Supports ONVIF Profile S
- Built in PoE Switch with direct IP camera connection
- Direct mouse control and remote control by network
- Open network mode or CCTV mode



DIMENSIONS (MM)

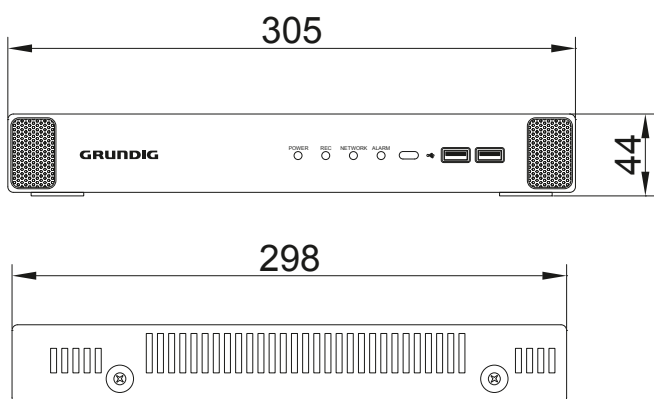

SPECIFICATIONS

Operating System:	Embedded Linux
IP Inputs:	4 channels
Video Outputs:	1 HDMI
Max. Storage Capacity:	28TB (2x4TB SATA and 5x4TB eSATA)
Harddisk bay:	2 x SATA II
Video Compression:	H.264
Recording Resolution:	max. 1920x1080 depending on the camera performance
Recording Speed:	100 fps
Recording Mode:	Continuous, Event Alarm, Motion, Video Loss, Schedule, Manual
Pre-Alarm:	Off, 1, 2, 3, 4, 5, 10, 15 sec.
Post-Alarm:	Off, 1, 2, 3, 4, 5, 10, 15, 30, sec., 1, 2, 3 min.
Display Resolution:	1920 x 1080
Display Speed:	100 fps
Display Mode:	Full screen, 4
PTZ Control:	Pan / Tilt / Zoom / Focus / Preset / Sequence / Auto Pan
Auto Switching:	1, 2, 3, 5, 10, 15, 20, 30, 40, 60 sec, Multi Channel Views
External Backup:	USB HDD, USB Memory, Network, FTP
Watermark:	Yes
Search Mode:	Date/Time, Event, Thumbnail
Motion Detection:	On/ Off/ Sensitivity/ Area setting
Event Source:	Motion, Alarm, Video Loss, System
Event Action:	Pop-Up, Relay, E-Mail, Buzzer, FTP
Number of Clients:	Up to 8 user (admin, manager, user)
Audio Inputs:	4 CH over IP, 1 x RCA
Audio Outputs:	1 CH, RCA
Audio Compression:	G.711
Alarm Inputs:	4 (IP) + 2 N/O or N/C
Alarm Outputs:	1 Relay
Network:	2 x 1000Mbps + 4 x 100Mbps (PoE, max. 60W)
Serial Interface(s):	1x RS232, 1x RS485, 3x USB, 1x eSATA
Multiplex Function:	Triplex
Network Protocol:	DHCP; HTTP; FTP; SMTP; RTP/RSTP; RTCP; NTP; DDNS; uPNP
Video Streaming:	Versatile Dual Streaming
Time Setting:	Setting by NTP Server local or internet
Client software:	Windows (XP, Vista, 7, 8), Web Viewer: IE, Firefox, Safari, Chrome; Mobile: iPhone, Android
Standards:	CE
Operating Temperature:	0°C ~ +40°C
Humidity:	less than 90%, non condensing
Supply Voltage:	12 VDC (NVR), 48 VDC (PoE Switch)
Power Consumption:	20 W
Weight:	4.09 kg
Dimensions (WxHxD):	305 x 44 x 298 mm



GRI-K2208A 8-Ch Full HD Standalone H.264 NVR

- High performance NVR with Full HD real-time recording
- Easy to use user interface
- Auto-configuration for Grundig IP cameras
- Supports ONVIF Profile S
- Built in PoE Switch with direct IP camera connection
- Direct mouse control and remote control by network
- Open network mode or CCTV mode



DIMENSIONS (MM)

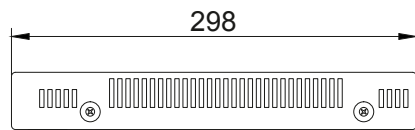
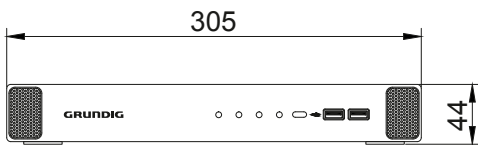

SPECIFICATIONS

Operating System:	Embedded Linux
IP Inputs:	8 channels
Video Outputs:	1 HDMI
Max. Storage Capacity:	28TB (2x4TB SATA and 5x4TB eSATA)
Harddisk bay:	2 x SATA II
Video Compression:	H.264
Recording Resolution:	max. 1920x1080 depending on the camera performance
Recording Speed:	200 fps
Recording Mode:	Continuous, Event Alarm, Motion, Video Loss, Schedule, Manual
Pre-Alarm:	Off, 1, 2, 3, 4, 5, 10, 15 sec.
Post-Alarm:	Off, 1, 2, 3, 4, 5, 10, 15, 30, sec., 1, 2, 3 min.
Display Resolution:	1920 x 1080
Display Speed:	200 fps
Display Mode:	Full screen, 4, 6, 8
PTZ Control:	Pan / Tilt / Zoom / Focus / Preset / Sequence / Auto Pan
Auto Switching:	1, 2, 3, 5, 10, 15, 20, 30, 40, 60 sec, Multi Channel Views
External Backup:	USB HDD, USB Memory, Network, FTP
Watermark:	Yes
Search Mode:	Date/Time, Event, Thumbnail
Motion Detection:	On/ Off/ Sensitivity/ Area setting
Event Source:	Motion, Alarm, Video Loss, System
Event Action:	Pop-Up, Relay, E-Mail, Buzzer, FTP
Number of Clients:	Up to 8 user (admin, manager, user)
Audio Inputs:	8 CH over IP, 1 x RCA
Audio Outputs:	1 CH, RCA
Audio Compression:	G.711
Alarm Inputs:	8 (IP) + 2 N/O or N/C
Alarm Outputs:	1 Relay
Network:	2 x 1000Mbps + 8 x 100Mbps (PoE, max. 72W)
Serial Interface(s):	1x RS232, 1x RS485, 3x USB, 1x eSATA
Multiplex Function:	Triplex
Network Protocol:	DHCP; HTTP; FTP; SMTP; RTP/RSTP; RTCP; NTP; DDNS; uPNP
Video Streaming:	Versatile Dual Streaming
Time Setting:	Setting by NTP Server local or internet
Client software:	Windows (XP, Vista, 7, 8), Web Viewer: IE, Firefox, Safari, Chrome; Mobile: iPhone, Android
Standards:	CE
Operating Temperature:	0°C - +40°C
Humidity:	less than 90%, non condensing
Supply Voltage:	12 VDC (NVR), 48 VDC (PoE Switch)
Power Consumption:	20 W
Weight:	4.11 kg
Dimensions (WxHxD):	305 x 44 x 298 mm



GRI-K4416A

16-Ch Full HD Standalone H.264 NVR

- High performance NVR with Full HD real-time recording
- H.264 compression modes
- Intuitive user interface
- Auto-configuration for Grundig IP cameras
- Supports ONVIF Profile S
- Built-in & external PoE switch for direct IP camera connection
- 19", 2U, rack-mounting
- Direct mouse control and remote control by network
- Open network mode or CCTV mode



DIMENSIONS (MM)

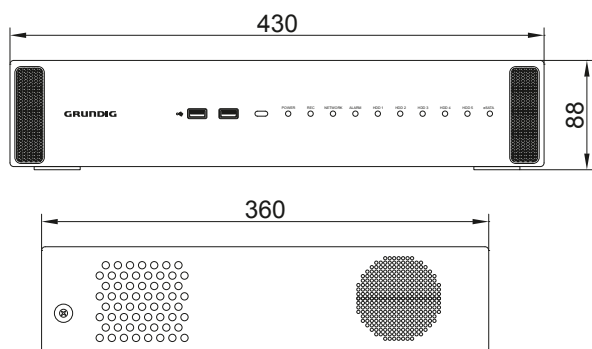

SPECIFICATIONS

Operating System:	Embedded Linux
IP Inputs:	16 channels
Video Outputs:	1 VGA, 1 HDMI
Max. Storage Capacity:	40 TB (5x4 TB SATA and 5x4 TB eSATA)
Harddisk bay:	5 x SATA II
Video Compression:	H.264
Recording Resolution:	max. 1920x1080 depending on the camera performance
Recording Speed:	400 fps
Recording Mode:	Continuous, Event Alarm, Motion, Video Loss, Schedule, Manual
Pre-Alarm:	Off, 1, 2, 3, 4, 5, 10, 15 sec.
Post-Alarm:	Off, 1, 2, 3, 4, 5, 10, 15, 30, sec., 1, 2, 3 min.
Display Resolution:	1920 x 1080
Display Speed:	400 fps
Display Mode:	Full screen, 4, 6, 8, 9, 16
PTZ Control:	Pan / Tilt / Zoom / Focus / Preset / Sequence / Auto Pan
Auto Switching:	1, 2, 3, 5, 10, 15, 20, 30, 40, 60 sec, Multi Channel Views
External Backup:	USB HDD, USB Memory, Network, FTP
Watermark:	Yes
Search Mode:	Date/Time, Event, Thumbnail
Motion Detection:	On/ Off/ Sensitivity/ Area setting
Event Source:	Motion, Alarm, Video Loss, System
Event Action:	Pop-Up, Relay, E-Mail, Buzzer, PTZ Preset, FTP
Number of Clients:	Up to 8 user (admin, manager, user)
Audio Inputs:	16 CH over IP, 1 x RCA
Audio Outputs:	1 CH, RCA
Audio Compression:	G.711
Alarm Inputs:	16 (IP) + 2 N/O or N/C
Alarm Outputs:	1 Relay
Network:	2 x 1000Mbps + 8 x 100Mbps (PoE, max. 100W) + 8 x 100Mbps (PoE, max. 72W, supplied external switch)
Serial Interface(s):	1x RS232, 1x RS485, 3x USB, 1x eSATA
Multiplex Function:	Triplex
Network Protocol:	DHCP; HTTP; FTP; SMTP; RTP/RSTP; RTCP; NTP; DDNS; uPNP
Video Streaming:	Versatile Dual Streaming
Time Setting:	Setting by NTP Server local or internet
Client software:	Windows (XP, Vista, 7, 8), Web Viewer: IE, Firefox, Safari, Chrome; Mobile: iPhone, Android
Standards:	CE
Operating Temperature:	0°C - +40°C
Humidity:	less than 90%, non condensing
Supply Voltage:	230 VAC (NVR), 48VDC (Switch)
Power Consumption:	25 W
Weight:	5.43 kg
Dimensions (WxHxD):	430 x 88 x 360 mm

HD VIDEO CAMERAS

High Definition - Serial Digital Interface (HD-SDI) CCTV combines the image quality of IP with the simple, point-to-point installation of analogue. It enables the transmission of decompressed digital video, in real time, over coaxial cable. HD-SDI technology provides a closed CCTV system which is simple to protect, install and maintain.





OVERVIEW HD CAMERAS



BOX CAMERAS

MODEL	PICTURE	IMAGE SENSOR	MINIMUM SENSITIVITY	FOCAL LENGTH	VIEWING ANGLE	LENS DRIVE TYPE	IR LED	WDR MODE	OPERATING TEMPERATURE	POWER SUPPLY	PAGE
GCH-K1305B-1		1/3" CMOS 2.1 Megapixel	0.1 Lux @ F1.2 (IRE50)	-	-	DC Auto Iris	-	Off/Low/Middle/High	-10°C ~ +50°C	12 VDC / 24 VAC	49

INDOOR FIXED DOMES

GCH-K1325D-1		1/3" CMOS 2.1 Megapixel	0.1 Lux @ F1.2 (IRE50)	2.8 ~ 10 mm	100° ~ 29°	DC Auto Iris	-	Off/Low/Middle/High	-10°C ~ +50°C	12 VDC / 24 VAC	50
GCH-K1327D-1		1/3" CMOS 2.1 Megapixel	0 Lux LED IR on	2.8 ~ 10 mm	100° ~ 29°	DC Auto Iris	28 pcs.	Off/Low/Middle/High	-10°C ~ +50°C	12 VDC / 24 VAC	51

OUTDOOR FIXED DOMES

GCH-K1325V-1		1/3" CMOS 2.1 Megapixel	0.1 Lux@ F1.2 (IRE50)	2.8 ~ 10 mm	100° ~ 29°	DC Auto Iris	-	Off/Low/Middle/High	-10°C ~ +50°C	12 VDC / 24 VAC	52
GCH-K1327V-1		1/3" CMOS 2.1 Megapixel	0 Lux LED IR on	2.8 ~ 10 mm	100° ~ 29°	DC Auto Iris	28 pcs.	Off/Low/Middle/High	-10°C ~ +50°C	12 VDC / 24 VAC	53

BULLET

GCH-K1327T-1		1/3" CMOS 2.1 Megapixel	0 Lux LED IR on	2.8 ~ 10 mm	100° ~ 29°	DC Auto Iris	42 pcs.	Off/Low/Middle/High	-10°C ~ +50°C	12 VDC / 24 VAC	54
--------------	---	-------------------------	-----------------	-------------	------------	--------------	---------	---------------------	---------------	-----------------	----



GCH-K1305B-1

2 MP Full HD CMOS Box EX-SDI Camera ICR WDR

- EX-SDI mode to increase transmission distance
- Full HD, 1920 x 1080p, video stream at up to 50/60 FPS over coax
- WDR (Wide Dynamic Range) for extreme backlight applications
- Video enhancement features including BLC, HLC and DNR
- Fast & easy Zoom/Focus adjustment mechanism
- 3 axis gimble for wall or ceiling mounting
- Built-in service monitor port & OSD control port
- HD-SDI mode for downwards compatibility
- Power input AC24V/DC12V



DIMENSIONS (MM)

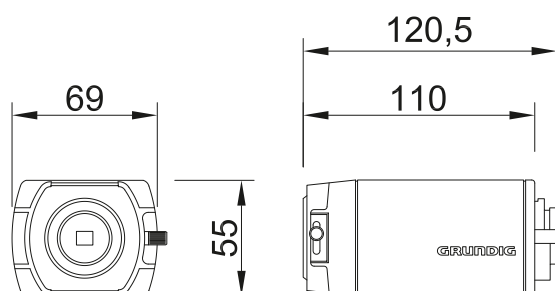

SPECIFICATIONS

Image Sensor:	1/3" CMOS Sony Exmor 2 Megapixel
Pixels - Total:	1952(H) x 1116(V)
Pixels - Effective:	1944(H) x 1104(V)
Scanning System:	Progressive
Image Size:	1920x1080, 1280x720
Frame Rate:	30/60, 25/50 fps at 1080p; 30/60, 25/50 fps at 720p
Sensitivity Colour:	0.5 Lux @ F1.2 (IRE50)
Sensitivity B&W:	0.1 Lux @ F1.2 (IRE50)
Sens Up:	Off ~ x32, auto
S/N Ratio:	>50 dB
Shutter Speed:	AUTO, FLK, Manual 1/25 ~ 1/30,000
Co/B&W:	On/Off/Auto/Ext, IR-cut filter removable (ICR)
Lens Drive Type:	DC Auto Iris, Manual
OSD:	Yes, multi language
Camera ID:	Off / On, 8 character
Flip/Mirror:	On/Off
WDR:	Off/Low/Middle/High
Number of Privacy Zones:	16 (standard method) + 8 (polygonal method)
BLC: Back Light:	BLC, HSBLC, OFF
Digital Noise Reduction (DNR):	Off/Low/Mid/High (Adaptive 3D + 2D)
Motion Detection:	On/ Off/ Sensitivity/ Area setting
Sharpness:	Off / On [0~20]
Digital Zoom:	Off/x2 ~ x62
White Balance:	ATW, AWB, AWC, Manual
De-Fog:	Off/Auto/Low/Middle/High
Presets:	Indoor, Outdoor, Lowlight, Hallway, Lobby, Elevator
Video Outputs:	1 Ch HD-SDI BNC or 1 Ch Composite BNC
Standards:	CE
Operating Temperature:	-10°C ~ +50°C
Storage Temperature:	-20°C ~ +60°C
Humidity:	less than 85%
Supply Voltage:	12 VDC / 24 VAC
Power Consumption:	3 W
Weight:	0.33 kg
Dimensions (WxHxD):	69 x 55 x 120.5 mm

ACCESSORIES

GBR-WA03





GCH-K1325D-1
2 MP Full HD CMOS Fixed Dome EX-SDI Camera
2,8~10mm ICR WDR

- EX-SDI mode to increase transmission distance
- Full HD, 1920 x 1080p, video stream at up to 50/60 FPS over coax
- WDR (Wide Dynamic Range) for extreme backlight applications
- Video enhancement features including BLC, HLC and DNR
- Fast & easy Zoom/Focus adjustment mechanism
- 3 axis gimble for wall or ceiling mounting
- Built-in service monitor port & OSD control port
- HD-SDI mode for downwards compatibility
- Power input AC24V/DC12V



DIMENSIONS (MM)

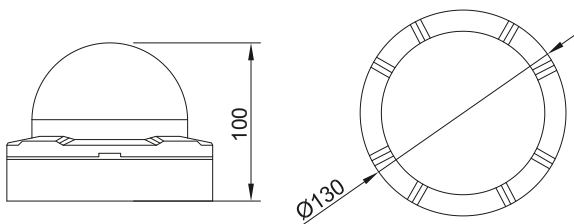

SPECIFICATIONS

Image Sensor:	1/3" CMOS Sony Exmor 2 Megapixel
Pixels - Total:	1952(H) x 1116(V)
Pixels - Effective:	1944(H) x 1104(V)
Scanning System:	Progressive
Image Size:	1920x1080, 1280x720
Frame Rate:	30/60, 25/50 fps at 1080p; 30/60, 25/50 fps at 720p
Sensitivity Colour:	0.5 Lux @ F1.2 (IRE50)
Sensitivity B&W:	0.1 Lux @ F1.2 (IRE50)
Sens Up:	Off - x32, auto
S/N Ratio:	>50 dB
Shutter Speed:	AUTO, FLK, Manual 1/25 ~ 1/30,000
Col/B&W:	On/Off/Auto/Ext, IR-cut filter removable (ICR)
Focal Length:	2.8 ~ 10 mm
Lens Drive Type:	DC Auto Iris
OSD:	Yes, multi language
Camera ID:	Off / On, 8 character
Flip/Mirror:	On/Off
WDR:	Off/Low/Middle/High
Number of Privacy Zones:	16 (standard method) + 8 (polygonal method)
BLC: Back Light:	BLC, HSBLC, OFF
Digital Noise Reduction (DNR):	Off/Low/Mid/High (Adaptive 3D + 2D)
Motion Detection:	On/ Off/ Sensitivity/ Area setting
Sharpness:	Off / On (0-20)
Digital Zoom:	Off/1 ~ 16x
White Balance:	ATW, AWB, AWC, Manual
De-Fog:	Off/Auto/Low/Middle/High
Presets:	Indoor, Outdoor, Lowlight, Hallway, Lobby, Elevator
Video Outputs:	1 Ch HD-SDI BNC or 1 Ch Composite BNC
Operating Temperature:	-10°C ~ +50°C
Storage Temperature:	-20°C ~ +60°C
Humidity:	less than 85%
Standards:	CE
Supply Voltage:	12 VDC / 24 VAC
Power Consumption:	3 W
Weight:	0.5 kg
Dimensions (WxHxD):	Ø 132 x 100 mm

ACCESSORIES

GBR-WA06

GBR-IC06





GCH-K1327D-1

2 MP Full HD CMOS Fixed Dome EX-SDI Camera 2,8~10mm IR 28 LED WDR

- EX-SDI mode to increase transmission distance
- Full HD, 1920 x 1080p, video stream at up to 50/60 FPS over coax
- WDR (Wide Dynamic Range) for extreme backlight applications
- Video enhancement features including BLC, HLC and DNR
- Fast & easy Zoom/Focus adjustment mechanism
- Smart IR LED control with level adjustment
- 0 Lux: Integrated IR LED illuminator for night-time operation
- 3 axis gimble for wall or ceiling mounting
- Built-in service monitor port & OSD control port
- HD-SDI mode for downwards compatibility
- Power input AC24V/DC12V



DIMENSIONS (MM)

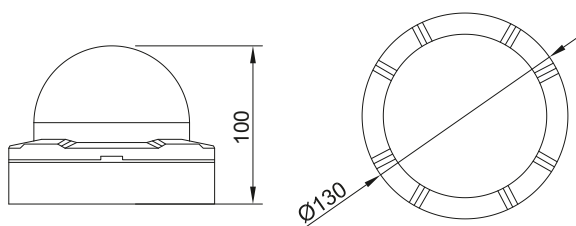

ACCESSORIES

GBR-WA06



GBR-IC06



SPECIFICATIONS

Image Sensor:	1/3" CMOS Sony Exmor 2 Megapixel
Pixels - Total:	1952(H) x 1116(V)
Pixels - Effective:	1944(H) x 1104(V)
Scanning System:	Progressive
Image Size:	1920x1080, 1280x720
Frame Rate:	30/60, 25/50 fps at 1080p; 30/60, 25/50 fps at 720p
Sensitivity Colour:	0.5 Lux @ F1.2 (IRE50)
Sensitivity B&W:	0 Lux LED IR on
Sens Up:	Off ~ x32, auto
S/N Ratio:	>50 dB
Shutter Speed:	AUTO, FLK, Manual 1/25 ~ 1/30,000
CoI/B&W:	On/Off/Auto/Ext, IR-cut filter removable (ICR)
Focal Length:	2.8 ~ 10 mm
Lens Drive Type:	DC Auto Iris
IR LED:	28 pcs.
Smart IR:	Off / On
Max. IR Distance:	30/45 m (according to scene reflexion)
OSD:	Yes, multi language
Camera ID:	Off / On, 8 character
Flip/Mirror:	On/Off
WDR:	Off/Low/Middle/High
Number of Privacy Zones:	16 (standard method) + 8 (polygonal method)
BLC: Back Light:	BLC, HSBLC, OFF
Digital Noise Reduction (DNR):	Off/Low/Mid/High (Adaptive 3D + 2D)
Motion Detection:	On/ Off/ Sensitivity/ Area setting
Sharpness:	Off / On [0~20]
Digital Zoom:	Off/1 ~ 16x
White Balance:	ATW, AWB, AWC, Manual
De-Fog:	Off/Auto/Low/Middle/High
Presets:	Indoor, Outdoor, Lowlight, Hallway, Lobby, Elevator
Video Outputs:	1 Ch HD-SDI BNC or 1 Ch Composite BNC
Standards:	CE
Operating Temperature:	-10°C ~ +50°C
Storage Temperature:	-20°C ~ +60°C
Humidity:	less than 85%
Supply Voltage:	12 VDC / 24 VAC
Power Consumption:	6 W
Weight:	0.5 kg
Dimensions (WxHxD):	Ø 132 x 100 mm



GCH-K1325V-1
2 MP Full HD CMOS VF Dome EX-SDI Camera
2,8~10mm ICR WDR

- EX-SDI mode to increase transmission distance
- Vandal resistant dome (IK10)
- Weatherproof case design (IP66)
- Full HD, 1920 x 1080p, video stream at up to 50/60 FPS over coax
- WDR (Wide Dynamic Range) for extreme backlight applications
- Video enhancement features including BLC, HLC and DNR
- Fast & easy Zoom/Focus adjustment mechanism
- 3 axis gimble for wall or ceiling mounting
- Built-in service monitor port & OSD control port
- HD-SDI mode for downwards compatibility
- Power input AC24V/DC12V



DIMENSIONS (MM)

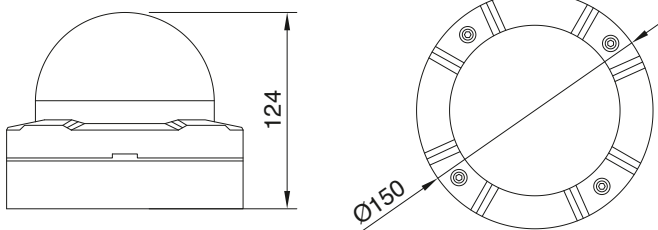

SPECIFICATIONS

Image Sensor:	1/3" CMOS Sony Exmor 2 Megapixel
Pixels - Total:	1952(H) x 1116(V)
Pixels - Effective:	1944(H) x 1104(V)
Scanning System:	Progressive
Image Size:	1920x1080, 1280x720
Frame Rate:	30/60, 25/50 fps at 1080p; 30/60, 25/50 fps at 720p
Sensitivity Colour:	0.5 Lux @ F1.2 (IRE50)
Sensitivity B&W:	0.1 Lux @ F1.2 (IRE50)
Sens Up:	Off - x32, auto
S/N Ratio:	>50 dB
Shutter Speed:	AUTO, FLK, Manual 1/25 ~ 1/30,000
Co/B&W:	On/Off/Auto/Ext, IR-cut filter removable (ICR)
Focal Length:	2.8 ~ 10 mm
Lens Drive Type:	DC Auto Iris
OSD:	Yes, multi language
Camera ID:	Off / On, 8 character
Flip/Mirror:	On/Off
WDR:	Off/Low/Middle/High
Number of Privacy Zones:	16 (standard method) + 8 (polygonal method)
BLC: Back Light:	BLC, HSBLC, OFF
Digital Noise Reduction (DNR):	Off/Low/Mid/High (Adaptive 3D + 2D)
Motion Detection:	On/ Off/ Sensitivity/ Area setting
Sharpness:	Off / On (0-20)
Digital Zoom:	Off/1 ~ 16x
White Balance:	ATW, AWB, AWC, Manual
De-Fog:	Off/Auto/Low/Middle/High
Presets:	Indoor, Outdoor, Lowlight, Hallway, Lobby, Elevator
Protection Rating:	IP66 / IK10
Video Outputs:	1 Ch HD-SDI BNC or 1 Ch Composite BNC
Standards:	CE
Operating Temperature:	-10°C ~ +50°C
Storage Temperature:	-20°C ~ +60°C
Humidity:	less than 85%
Supply Voltage:	12 VDC / 24 VAC
Power Consumption:	3 W
Weight:	1.12 kg
Dimensions (WxHxD):	Ø 150 x 124 mm

ACCESSORIES

GBR-WA04



GBR-CE02



GBR-WB02



GBR-PM02



GBR-IC04





GCH-K1327V-1

2 MP Full HD CMOS VF Dome EX-SDI 2,8-10mm Camera IR 28 LED WDR

- EX-SDI mode to increase transmission distance
- Vandal resistant dome (IK10)
- Weatherproof case design (IP66)
- Full HD, 1920 x 1080p, video stream at up to 50/60 FPS over coax
- WDR (Wide Dynamic Range) for extreme backlight applications
- Video enhancement features including BLC, HLC and DNR
- Smart IR LED control with level adjustment
- 0 Lux: Integrated IR LED illuminator for night-time operation
- Fast & easy Zoom/Focus adjustment mechanism
- 3 axis gimble for wall or ceiling mounting
- Built-in service monitor port & OSD control port
- HD-SDI mode for downwards compatibility
- Power input AC24V/DC12



DIMENSIONS (MM)

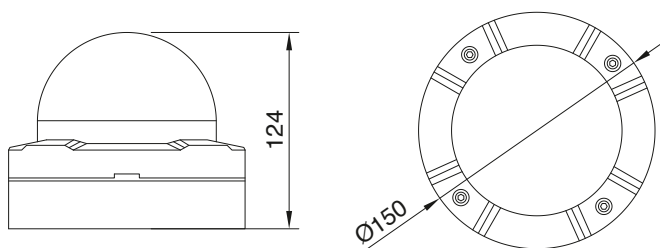

SPECIFICATIONS

Image Sensor:	1/3" CMOS Sony Exmor 2 Megapixel
Pixels - Total:	1952(H) x 1116(V)
Pixels - Effective:	1944(H) x 1104(V)
Scanning System:	Progressive
Image Size:	1920x1080, 1280x720
Frame Rate:	30/60, 25/50 fps at 1080p; 30/60, 25/50 fps at 720p
Sensitivity Colour:	0.5 Lux @ F1.2 (IRE50)
Sensitivity B&W:	0 Lux LED IR on
Sens Up:	Off - x32, auto
S/N Ratio:	>50 dB
Shutter Speed:	AUTO, FLK, Manual 1/25 - 1/30,000
CoI/B&W:	On/Off/Auto/Ext, IR-cut filter removable (ICR)
Focal Length:	2.8 - 10 mm
Lens Drive Type:	DC Auto Iris
IR LED:	28 pcs.
Smart IR:	Off / On
Max. IR Distance:	30/45 m (according to scene reflexion)
OSD:	Yes, multi language
Camera ID:	Off / On, 8 character
Flip/Mirror:	On/Off
WDR:	Off/Low/Middle/High
Number of Privacy Zones:	16 (standard method) + 8 (polygonal method)
BLC: Back Light:	BLC, HSBLC, OFF
Digital Noise Reduction (DNR):	Off/Low/Mid/High (Adaptive 3D + 2D)
Motion Detection:	On/ Off/ Sensitivity/ Area setting
Sharpness:	Off / On [0-20]
Digital Zoom:	Off/x2 - x62
White Balance:	ATW, AWB, AWC, Manual
De-Fog:	Off/Auto/Low/Middle/High
Presets:	Indoor, Outdoor, Lowlight, Hallway, Lobby, Elevator
Video Outputs:	1 Ch HD-SDI BNC or 1 Ch Composite BNC
Standards:	CE
Operating Temperature:	-10°C ~ +50°C
Storage Temperature:	-20°C ~ +60°C
Humidity:	less than 85%
Supply Voltage:	12 VDC / 24 VAC
Power Consumption:	6 W
Weight:	0.5 kg
Dimensions (WxHxD):	Ø 150 x 124 mm

ACCESSORIES

GBR-WA04



GBR-CE02



GBR-WB02



GBR-PM02



GBR-IC04





GCH-K1327T-1

2 MP Full HD CMOS Bullet EX-SDI Camera 2,8-10mm

IR 42 LED WDR

- EX-SDI mode to increase transmission distance
- Full HD, 1920 x 1080p, video stream at up to 50/60 FPS over coax
- WDR (Wide Dynamic Range) for extreme backlight applications
- Video enhancement features including BLC, HLC and DNR
- Smart IR LED control with level adjustment
- 0 Lux: Integrated IR LED illuminator for night-time operation
- 4 axis wall-mount arm for flexible installation
- Weatherproof case design (IP66)
- Externally adjustable vari-focal, DC lens
- HD-SDI mode for downwards compatibility
- Power input AC24V/DC12V



DIMENSIONS (MM)

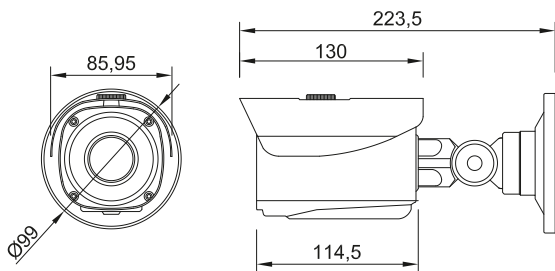

SPECIFICATIONS

Image Sensor:	1/3" CMOS Sony Exmor 2 Megapixel
Pixels - Total:	1952(H) x 1116(V)
Pixels - Effective:	1944(H) x 1104(V)
Scanning System:	Progressive
Image Size:	1920x1080, 1280x720
Frame Rate:	30/60, 25/50 fps at 1080p; 30/60, 25/50 fps at 720p
Sensitivity Colour:	0.5 Lux @ F1.2 (IRE50)
Sensitivity B&W:	0 Lux LED IR on
Sens Up:	Off - x32, auto
S/N Ratio:	>50 dB
Shutter Speed:	AUTO, FLK, Manual 1/25 - 1/30,000
CoI/B&W:	On/Off/Auto/Ext, IR-cut filter removable (ICR)
Focal Length:	2.8 - 10 mm
Lens Drive Type:	DC Auto Iris
IR LED:	42 pcs.
Smart IR:	Off / On
Max. IR Distance:	30/45 m (according to scene reflexion)
OSD:	Yes, multi language
Camera ID:	Off / On, 8 character
Flip/Mirror:	On/Off
WDR:	Off/Low/Middle/High
Number of Privacy Zones:	8 (polygonal method)
BLC: Back Light:	BLC, HSBLC, OFF
Digital Noise Reduction (DNR):	Off/Low/Mid/High [Adaptive 3D + 2D]
Motion Detection:	On/ Off/ Sensitivity/ Area setting
Sharpness:	Off / On (0-20)
Digital Zoom:	Off/1 - 16x
White Balance:	ATW, AWB, AWC, Manual
De-Fog:	Off/Auto/Low/Middle/High
Presets:	Indoor, Outdoor, Lowlight, Hallway, Lobby, Elevator
Protection Rating:	IP66
Video Outputs:	1 Ch HD-SDI BNC or 1 Ch Composite BNC
Operating Temperature:	-10°C ~ +50°C
Storage Temperature:	-20°C ~ +60°C
Humidity:	less than 85%
Supply Voltage:	12 VDC / 24 VAC
Standards:	CE
Power Consumption:	9 W
Weight:	1.14 kg
Dimensions (WxHxD):	99 x 223.5 mm

ACCESSORIES

GBR-FB03



GBR-PM02



EX-SDI



EX-SDI TECHNOLOGY

The EX-SDI (Extended Serial Digital Interface) is a transmission method to overcome the transmission distance limitations of HD-SDI technology.

The HD-SDI signal will be compressed to 270Mb/s instead of up to 2.97Gb/s for an uncompressed Full HD HD-SDI signal.

This compression is visually almost not noticeable and is executed within less than 100µs, so the advantages of HD-SDI will be kept up, while the limitation will be removed.

With EX-SDI you can increase the transmission distance on an RG59 cable from 100m for an Full HD signal, or 160m for an HD signal up to 330m with EX-SDI.

With higher quality cable (for example RG11) you can reach more than 600m transmission distance instead of 200m.



CABLE TYPE	EX-SDI: 270MB/S	HD: 1.485GB/S	FULL HD: 2.97 GB/S
RG59	330m	160m	100m
RG6	375m	185m	120m
RG11	670m	330m	220m

(*the actual result depends on the quality of the cable and the connectors and can differ from this table)

STANDALONE HDVR

THE STANDALONE HDVR RANGE FROM GRUNDIG CONNECTS WITH CAMERAS USING COAXIAL CABLE. NETWORK ACCESS ENABLES REMOTE UPDATES, MAINTENANCE, MULTI-SITE CONTROL AND MANAGEMENT.

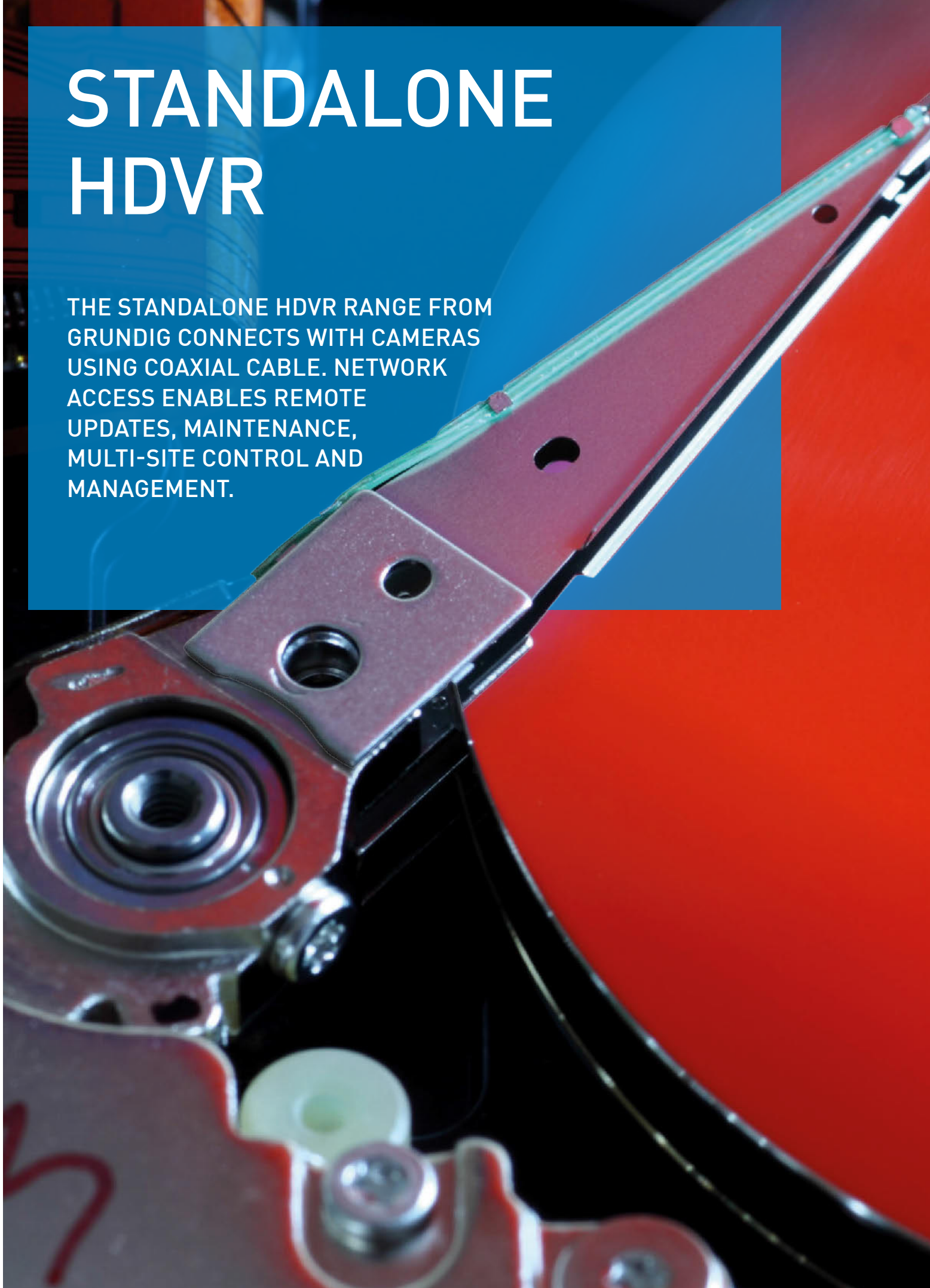



OVERVIEW HDVR RECORDERS

HDVR RECORDERS

MODEL	PICTURE	CHAN.	RECORDING RESOLUTION	RECORDING SPEED	SATA	eSATA	MAX. STORAGE CAPACITY	VIDEO OUT	AUDIO IN	ALARM IN	ALARM OUT	PAGE
GRH-K1104B		4 CH HD-SDI, BNC	FullHD (1920x1080), HD (1280x720)	120fps (FullHD), 120fps (HD)	4 x SATA II	yes	20 TB (4x4 TB SATA and 1x4 TB eSATA)	1 HDMI	4 CH, RCA	4 contact input N/O or N/C	2 Relay	59
GRH-K2108B		8 CH HD-SDI (BNC)	FullHD (1920x1080), HD (1280x720)	120fps (FullHD), 240fps (HD)	4 x SATA II	yes	20 TB (4x4 TB SATA and 1x4 TB eSATA)	1 HDMI	4 CH, RCA	8 contact input N/O or N/C	2 Relay	60
GRH-K4116B		16 CH HD-SDI, BNC	FullHD (1920x1080), HD (1280x720)	120fps (FullHD), 240fps (HD)	4 x SATA II	yes	20 TB (4x4 TB SATA and 1x4 TB eSATA)	1 HDMI	4 CH, RCA	16 contact input N/O or N/C	2 Relay	61
GRX-K4416A		16 CH HD-SDI or Ex-HD-SDI or Composite, BNC	FullHD (1920x1080), HD (1280x720), 960H (960x576), Full D1 (720x576)	400/480 fps	4 x SATA II	yes	32TB (intern or eSATA)	1 VGA, 1 HDMI, 1 BNC Spot	4 CH, RCA	16 contact input N/O or N/C	4 Relay	62



GRH-K1104B

4 Channel H.264 HD-SDI Recorder with DVD Drive

- 4 channel Full-HD, 120FPS recording and up to 120FPS live
- Search by time, date or event
- Supports up to 16TB internally, 64TB externally (GDS-R04A) or eSATA
- USB 2.0 interface
- Built in DVD-RW drive
- Compatible with Grundig Control Center Software (GCMS)
- Free DDNS service
- Multiplex (Live/Playback, Recording, Backup, Networking)
- Compatible with mobile applications including iPhone®, Blackberry®, Android® and Windows Mobile®
- Compatible with French law for CCTV installation quality (August 2007)
- Mobile client support - iPhone, iPad and Android



DIMENSIONS (MM)

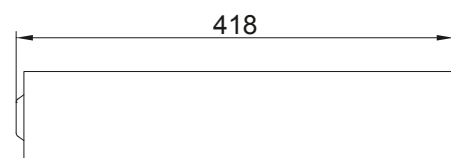
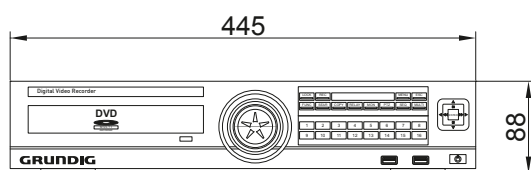

ACCESSORIES

GKB-A0110M



SPECIFICATIONS

Operating System:	Embedded OS
Video Inputs:	4 CH HD-SDI, BNC
Video Outputs:	1 HDMI
Harddisk bay:	4 x SATA II
Max. Storage Capacity:	20 TB (4x4 TB SATA and 1x4 TB eSATA)
Video Compression:	H.264
Recording Resolution:	FullHD (1920x1080), HD (1280x720)
Recording Speed:	120fps (FullHD), 120fps (HD)
Recording Mode:	Continuous, Event (Alarm, Motion, Video Loss), Schedule, Manual
Display Resolution:	1920 x 1080
Auto Switching:	3, 5, 10, 20, 30 sec, Event or manual, Multi Channel Views
Display Speed:	120 fps
Internal Backup:	Built in DVD writer
External Backup:	USB HDD, USB Memory, DVD-R, Network
Watermark:	Yes
Search Mode:	Date/Time, Event
Motion Detection:	On/ Off/ Area Setting
Event Source:	Motion, Alarm, Text, Video Loss, System
Event Action:	Pop-Up, Relay, E-Mail, FTP, Network, Buzzer, PTZ Preset
Audio Inputs:	4 CH, RCA
Audio Outputs:	1 CH, HDMI
Alarm Inputs:	4 contact input N/O or N/C
Alarm Outputs:	2 Relay
Compliant:	SMPTE 274M/292M/296M
Serial Interface(s):	1x RS232, 2x RS485, 2x USB, 1x eSATA
ATM/POS:	Supports up to 4 ATM/POS with VSI-Pro Hydra Modules
Video Streaming:	Versatile Triple Streaming (Dual H.264 + single JPEG)
Time Setting:	Setting by NTP Server local or internet
Multiplex Function:	Pentaplex
Network:	Ethernet, 10/100 Base-T for PC client, ADSL Static IP, ADSL Dynamic IP(PPPoE), Cable Network (Dynamic IP)
Client software:	Windows (XP, Vista, 7), Web Viewer: IE, Firefox, Safari, Chrome; Mobile: iPhone, Android
Standards:	CE
Operating Temperature:	5°C ~ +45°C
Humidity:	less than 90%, non condensing
Supply Voltage:	110 ~ 240 VAC/50Hz
Power Consumption:	100 W
Weight:	10 kg
Dimensions (WxHxD):	445 x 88 x 418 mm



GRH-K2108B

8 Channel H.264 HD-SDI Recorder with DVD-RW Drive

- 8 channel Full-HD, 120FPS recording and up to 240FPS live
- Search by time, date or event
- Supports up to 16TB internally, 64TB externally (GDS-R04A) or eSATA
- USB 2.0 interface and eSATA interface
- Built in DVD-RW drive
- Compatible with Grundig Control Center Software (GCMS)
- Free DDNS service
- Multiplex (Live/Playback, Recording, Backup, Networking)
- Compatible with mobile applications including iPhone®, Blackberry®, Android® and Windows Mobile®
- Compatible with French law for CCTV installation quality (August 2007)
- Mobile client support - iPhone, iPad and Android



DIMENSIONS (MM)

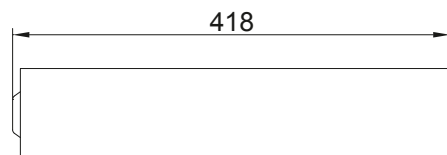
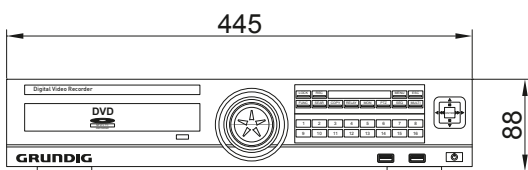

ACCESSORIES

GKB-A0110M



SPECIFICATIONS

Operating System:	Embedded OS
Video Inputs:	8 CH HD-SDI (BNC)
Video Outputs:	1 HDMI
Harddisk bay:	4 x SATA II
Max. Storage Capacity:	20 TB (4x4 TB SATA and 1x4 TB eSATA)
Video Compression:	H.264
Recording Resolution:	FullHD (1920x1080), HD (1280x720)
Recording Speed:	120fps (FullHD), 240fps (HD)
Recording Mode:	Continuous, Event (Alarm, Motion, Video Loss), Schedule, Manual
Display Resolution:	1920 x 1080
Auto Switching:	3, 5, 10, 20, 30 sec, Event or manual, Multi Channel Views
Display Speed:	240 fps
Internal Backup:	Built in DVD writer
External Backup:	USB HDD, USB Memory, DVD-R, Network
Watermark:	Yes
Search Mode:	Date/Time, Event
Motion Detection:	On/ Off/ Area Setting
Event Source:	Motion, Alarm, Text, Video Loss, System
Event Action:	Pop-Up, Relay, E-Mail, FTP, Network, Buzzer, PTZ Preset
Audio Inputs:	4 CH, RCA
Audio Outputs:	2 CH, RCA & HDMI
Alarm Inputs:	8 contact input N/O or N/C
Alarm Outputs:	2 Relay
Compliant:	SMPTE 274M/292M/296M
Serial Interface(s):	1x RS232, 2x RS485, 2x USB, 1x eSATA
ATM/POS:	Supports up to 8 ATM/POS with VSI-Pro Hydra Modules
Video Streaming:	Versatile Triple Streaming (Dual H.264 + single JPEG)
Time Setting:	Setting by NTP Server local or internet
Multiplex Function:	Pentaplex
Network:	Ethernet, 10/100 Base-T for PC client, ADSL Static IP, ADSL Dynamic IP(PPPoE), Cable Network (Dynamic IP)
Client software:	Windows (XP, Vista, 7), Web Viewer: IE, Firefox, Safari, Chrome; Mobile: iPhone, Android
Standards:	CE
Operating Temperature:	5°C ~ +45°C
Humidity:	less than 90%, non condensing
Supply Voltage:	110 ~ 240 VAC/50Hz
Power Consumption:	100 W
Weight:	10 kg
Dimensions (WxHxD):	445 x 88 x 418 mm



GRH-K4116B

16 Channel H.264 HD-SDI Recorder with DVD-RW Drive

- 8 channel Full-HD, 120FPS recording and up to 480FPS live
- Search by time, date or event
- Supports up to 16TB internally, 64TB externally (GDS-R04A) or eSATA
- USB 2.0 interface and eSATA interface
- Built in DVD-RW drive
- Compatible with Grundig Control Center Software (GCMS)
- Free DDNS service
- Multiplex (Live/Playback, Recording, Backup, Networking)
- Compatible with mobile applications including iPhone®, Blackberry®, Android® and Windows Mobile®
- Compatible with French law for CCTV installation quality (August 2007)
- Mobile client support - iPhone, iPad and Android



DIMENSIONS (MM)

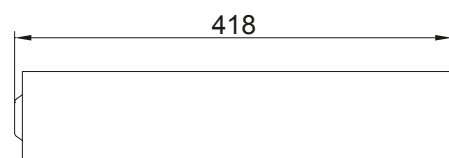
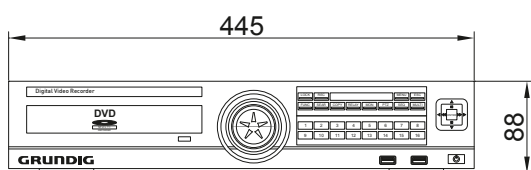

ACCESSORIES

GKB-A0110M



SPECIFICATIONS

Operating System:	Embedded OS
Video Inputs:	16 CH HD-SDI, BNC
Video Outputs:	1 HDMI
Harddisk bay:	4 x SATA II
Max. Storage Capacity:	20 TB (4x4 TB SATA and 1x4 TB eSATA)
Basic Internal Storage:	No
Video Compression:	H.264
Recording Resolution:	FullHD (1920x1080), HD (1280x720)
Recording Speed:	120fps (FullHD), 240fps (HD)
Recording Mode:	Continuous, Event (Alarm, Motion, Video Loss), Schedule, Manual
Display Resolution:	1920 x 1080
Auto Switching:	3, 5, 10, 20, 30 sec, Event or manual, Multi Channel Views
Display Speed:	400 fps
Internal Backup:	Built in DVD writer
External Backup:	USB HDD, USB Memory, DVD-R, Network
Watermark:	Yes
Search Mode:	Date/Time, Event
Motion Detection:	On/ Off/ Area Setting
Event Source:	Motion, Alarm, Text, Video Loss, System
Event Action:	Pop-Up, Relay, E-Mail, FTP, Network, Buzzer, PTZ Preset
Audio Inputs:	4 CH, RCA
Audio Outputs:	2 CH, RCA & HDMI
Alarm Inputs:	16 contact input N/O or N/C
Alarm Outputs:	2 Relay
Compliant:	SMPTE 274M/292M/296M
Serial Interface(s):	1x RS232, 2x RS485, 2x USB, 1x eSATA
ATM/POS:	Supports up to 16 ATM/POS with VSI-Pro Hydra Modules
Video Streaming:	Versatile Triple Streaming (Dual H.264 + single JPEG)
Time Setting:	Setting by NTP Server local or internet
Multiplex Function:	Pentaplex
Network:	Ethernet, 10/100 Base-T for PC client, ADSL Static IP, ADSL Dynamic IP(PPPoE), Cable Network (Dynamic IP)
Client software:	Windows (XP, Vista, 7), Web Viewer: IE, Firefox, Safari, Chrome; Mobile: iPhone, Android
Standards:	CE
Operating Temperature:	5°C ~ +45°C
Humidity:	less than 90%, non condensing
Standards:	CE
Supply Voltage:	110 ~ 240 VAC/50Hz
Power Consumption:	100 W
Weight:	10 kg
Dimensions (WxHxD):	445 x 88 x 418 mm



GRX-K4416A

16 Channel H.264 HD-SDI Hybrid-Recorder 2TB

- 16 Channel FullHD 480fps recording capability
- Hybrid DVR, support HD-SDI, Ex-HD-SDI and analog cameras
- Automatic signal type detection
- Proprietary file system with data-loss protection against power-failure
- Spot Monitor with 16-Split View and editable Sequence Function
- Search by time, calendar or event
- Free DDNS service
- Compatible with Grundig Control Center Software
- Mobile client support - iPhone, iPad, Android



DIMENSIONS (MM)

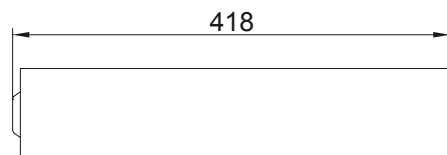
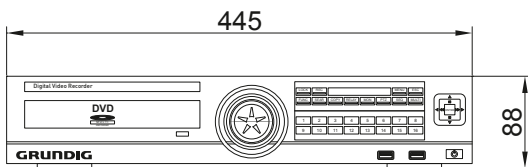

ACCESSORIES

GKB-A0110M



SPECIFICATIONS

Operating System:	Embedded OS
Video Inputs:	16 CH HD-SDI or Ex-HD-SDI or Composite, BNC
Video Outputs:	1 VGA, 1 HDMI, 1 BNC Spot (HD-SDI)
Harddisk bay:	4 x SATA II
Max. Storage Capacity:	32B (intern or eSATA)
Basic Internal Storage:	2 TB
Video Compression:	H.264
Recording Resolution:	FullHD (1920x1080), HD (1280x720), 960H (960x576), Full D1 (720x576)
Recording Speed:	400/480 fps
Recording Mode:	Continuous, Event (Alarm, Motion, Video Loss), Schedule, Manual
Display Resolution:	1920 x 1080
Auto Switching:	3, 5, 10, 20, 30 sec, Event or manual, Multi Channel Views
Display Speed:	400/480 fps
External Backup:	USB HDD, USB Memory, Network
Watermark:	Yes
Search Mode:	Date/Time, Event, Thumbnail
Motion Detection:	On/ Off/ Area Setting
Event Source:	Motion, Alarm, Text, Video Loss, System
Event Action:	Pop-Up, Relay, E-Mail, FTP, Network, Buzzer, PTZ Preset
Audio Inputs:	4 CH, RCA
Audio Outputs:	2 CH, RCA & HDMI
Alarm Inputs:	16 contact input N/O or N/C
Alarm Outputs:	4 Relay
Compliant:	SMPTE-292, 960H, 760H, Ex-SDI
Serial Interface(s):	1x RS232, 2x RS485, 2x USB, 1x eSATA
ATM/POS:	Supports up to 16 ATM/POS with VSI-Pro Hydra Modules
Video Streaming:	Versatile Triple Streaming (Dual H.264 + single JPEG)
Time Setting:	Setting by NTP Server local or internet
Multiplex Function:	Pentaplex
Network:	2 x 10/100/1000Mbps
Client software:	Windows (XP, Vista, 7), Web Viewer: IE, Firefox, Safari, Chrome; Mobile: iPhone, Android
Operating Temperature:	5°C ~ +45°C
Standards:	CE
Humidity:	less than 90%, non condensing
Supply Voltage:	110 ~ 240 VAC/50Hz
Power Consumption:	100 W
Weight:	10 kg
Dimensions (WxHxD):	445 x 88 x 418 mm

EX-SDI & HD-SDI & ANALOGUE RECORDER GRX-K4416A

The GRX-K4416A is a versatile and smart Hybrid DVR. It can record not only signals from the new EX-SDI cameras, but also standard HD-SDI cameras, and analogue 960H and 760H cameras.

The signals are detected automatically, therefore no configuration is needed and you have a true Plug & Play system that is easy to use and versatile in its applications.

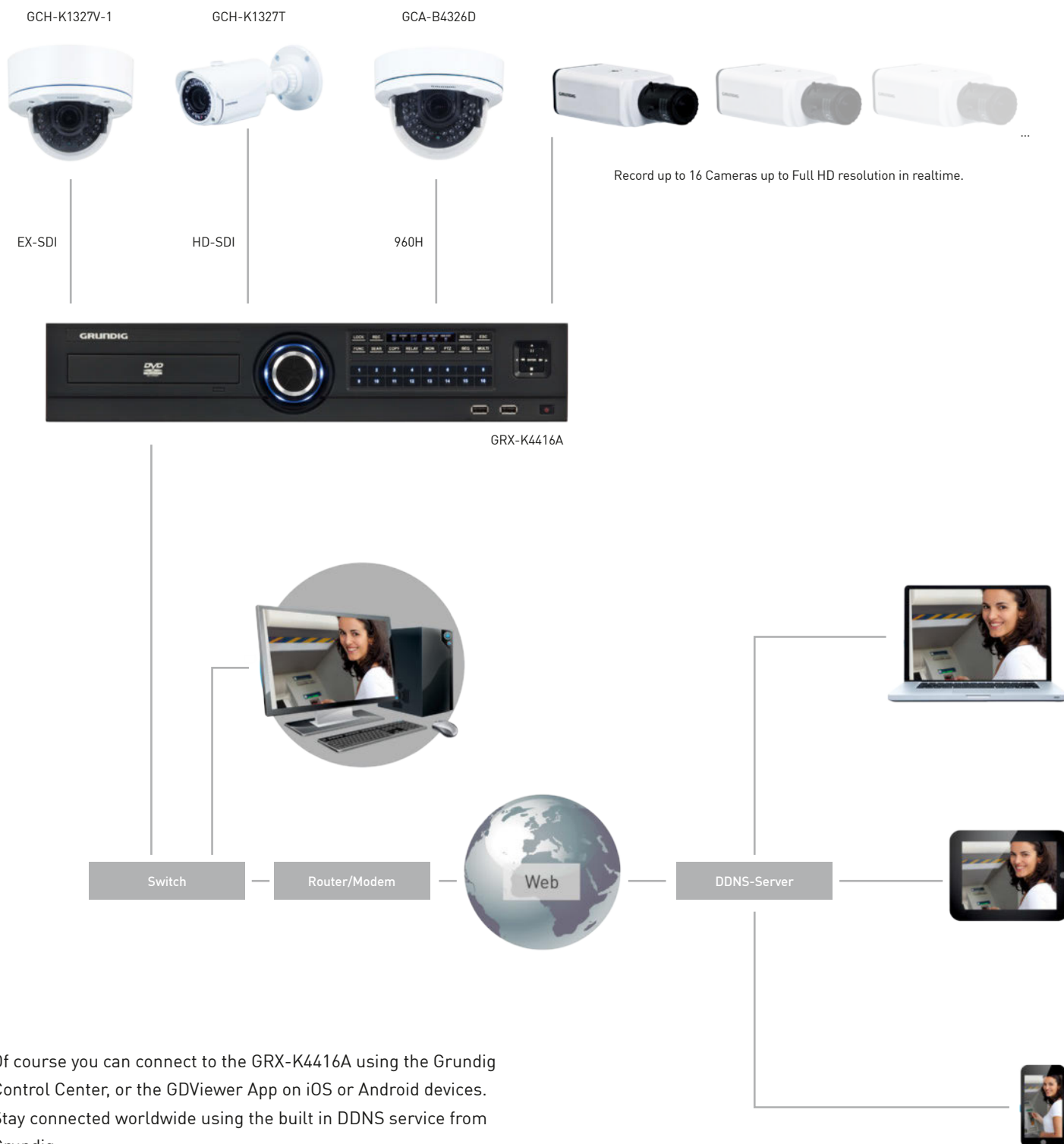

Of course you can connect to the GRX-K4416A using the Grundig Control Center, or the GDViewer App on iOS or Android devices. Stay connected worldwide using the built in DDNS service from Grundig

ANALOGUE CAMERAS





GRUNDIG ANALOGUE CAMERAS DELIVER OUTSTANDING IMAGE QUALITY USING THE VERY BEST IMAGE SENSORS, LENSES AND DIGITAL SIGNAL PROCESSORS. THE CAMERAS HAVE BEEN DESIGNED FOR UP-TO-DATE SURVEILLANCE APPLICATIONS AND INCORPORATE FUNCTIONALITY SUCH AS 960H AND 1.3 MEGAPIXEL (1000TVL) TECHNOLOGY, EXTENDED DYNAMIC RANGE AND DIGITAL NOISE REDUCTION.









OVERVIEW ANALOGUE CAMERAS







BOX CAMERAS

MODEL	PICTURE	IMAGE SENSOR	MINIMUM SENSITIVITY	DAY/NIGHT	PRIVACY ZONES	LENS DRIVE TYPE	COAXI-TRON	WDR MODE	OPERATING TEMPERATURE	POWER SUPPLY	PAGE
GCA-B1002B		650L 1/3" CCD	0,01 Lux	EL	15	DC auto iris	YES	ATR	-25°C ~ +55°C	100 ~ 240 VAC	68
GCA-B1005B		700L 1/3" CCD	0,001 Lux	ICR	15	DC auto iris	YES	WDR	-25°C ~ +55°C	100 ~ 240 VAC	69
GCA-B1302B		650L 1/3" CCD	0,01 Lux	EL	15	DC auto iris	YES	ATR	-25°C ~ +55°C	12VDC/24VAC	70
GCA-B1305B		700L 1/3" CCD	0,001 Lux	ICR	15	DC auto iris	YES	WDR	-25°C ~ +55°C	12VDC/24VAC	71

INDOOR FIXED DOMES





MODEL	PICTURE	IMAGE SENSOR	MINIMUM SENSITIVITY	FOCAL LENGTH	VIEWING ANGLE	LENS	IR LED	WDR MODE	OPERATING TEMPERATURE	POWER SUPPLY	PAGE
GCA-H0325D		1000L 1/3" CMOS	0,001 Lux	2.8 - 12 mm	102° ~ 27°	DC auto iris	28 pcs	WDR	-25°C ~ +55°C	12VDC/24VAC	72
GCA-B4322D		650L 1/3" CCD	0,8 Lux	2.8 - 12 mm	97° ~ 24°	DC auto iris	-	ATR	-25°C ~ +55°C	12VDC/24VAC	73
GCA-B4326D		700L 1/3" CCD	0,1 Lux	2.8 - 12 mm	97° ~ 24°	DC auto iris	28 pcs.	ATR	-25°C ~ +55°C	12VDC/24VAC	74
GCA-B4325D		700L 1/3" CCD	0,5 Lux	2.8 - 10,5 mm	102° ~ 27°	DC auto iris	-	WDR	-25°C ~ +55°C	12VDC/24VAC	75
GCA-B4327D		700L 1/3" CCD	0,5 Lux	2.8 - 10,5 mm	102° ~ 27°	DC auto iris	28 pcs.	WDR	-25°C ~ +55°C	12VDC/24VAC	76

OUTDOOR FIXED DOMES



GCA-H0325V		1000L 1/3" CMOS	0,001 Lux	2.8 - 12 mm	102° ~ 27°	DC auto iris	28 pcs.	WDR	-25°C ~ +55°C	12VDC/24VAC	77
GCA-B4323V		700L 1/3" CCD	0,1 Lux	2.8 - 12 mm	97° ~ 24°	DC auto iris	-	ATR	-25°C ~ +55°C	12VDC/24VAC	78
GCA-B4326V		700L 1/3" CCD	0,1 Lux	2.8 - 12 mm	97° ~ 24°	DC auto iris	28 pcs.	ATR	-25°C ~ +55°C	12VDC/24VAC	79
GCA-B4325V		700L 1/3" CCD	0,5 Lux	2.8 - 10,5 mm	102° ~ 27°	DC auto iris	-	WDR	-25°C ~ +55°C	12VDC/24VAC	80
GCA-B5326V		700L 1/3" CCD	0,5 Lux	2.8 - 10,5 mm	102° ~ 27°	DC auto iris	28 pcs.	ATR-Ex (dWDR)	-25°C ~ +55°C	12VDC/24VAC	81
GCA-B4327V		700L 1/3" CCD	0,5 Lux	2.8 - 10,5 mm	102° ~ 27°	DC auto iris	28 pcs.	WDR	-25°C ~ +55°C	12VDC/24VAC	82
GCA-B5325V		700L 1/3" CCD	0,5 Lux	9 - 22 mm	31° ~ 14°	DC auto iris	-	WDR	-25°C ~ +55°C	12VDC/24VAC	83

MODEL	PICTURE	IMAGE SENSOR	MINIMUM SENSITIVITY	FOCAL LENGTH	VIEWING ANGLE	LENS DRIVE TYPE	IR LED	WDR MODE	OPERATING TEMPERATURE	POWER SUPPLY	PAGE
GCA-C2357V		700L 1/3" CCD	0,01 Lux	3,8-38 mm MZ	50° - 5.5°	DC auto iris	28	dWDR	-25°C ~ +55°C	12VDC/24VAC	84

BULLET

GCA-B0325T		1000L 1/3" CMOS	0,001 Lux	2.8-12 mm	102° ~ 27°	DC auto iris	42 pcs.	WDR	-25°C ~ +55°C	12VDC/24VAC	85
GCA-B2326T		700L 1/3" CCD	0,1 Lux	2.8-12 mm	96,7° ~ 24,1°	DC auto iris	42 pcs.	ATR-Ex (dWDR)	-25°C ~ +55°C	12VDC/24VAC	86
GCA-B3326T		700L 1/3" CCD	0,2 Lux	5-50 mm	51.5° ~ 6.5°	DC auto iris	42 pcs.	ATR-Ex (dWDR)	-25°C ~ +55°C	12VDC/24VAC	87
GCA-B2357T		700L 1/3" CCD	0,01 Lux	3.8 - 38 mm	50° ~ 5.5°	DC auto iris	42 pcs.	dWDR	-25°C ~ +55°C	12VDC/24VAC	88

MOTORISED DOMES

GCA-C0335P		700L 1/4" CMOS	0,01Lux	3.8 ~ 45.6 mm	52,8 ~ 4,49°	Motorised Zoom & Focus, DC auto iris	-	WDR	0°C ~ +40°C	24VAC/4VDC	89
GCA-C0245P		700L 1/4" CMOS	0,001Lux	3.4 ~ 122.4 mm	52,8° ~ 4,59°	Motorised Zoom & Focus, DC auto iris	-	WDR	-40°C ~ +50°C	24VAC	90



GCA-B1002B

1/3" CCD Colour Box Camera, 650TVL, 230VAC

- 650 TV Lines excellent high horizontal resolution
- High Sensitivity of 0,01 Lux
- High Light Compensation (Conversion of peaklight into grey-scale)
- ATR (Adaptive Tone-curve Reproduction) Pixel-to pixel based tone-curve correction optimizes the contrast of image similar to WDR. ATR mode makes low luminance area brighter and high luminance area darker.
- Power input AC 100 - 240V



SPECIFICATIONS

Image Sensor:	1/3" CCD Sony 960H Ex-view HAD II
Scanning System:	PAL, 50Hz, 2:1 Inter Line Transfer
Pixels - Effective:	976(H) x 582(V)
Resolution:	650 (H) lines
Col/B&W:	Auto (Electronic) / Color / B/W / External
Sensitivity Colour:	0.01 Lux (50IRE) @ F1.2
S/N Ratio:	>52dB (AGC off)
Lens Mount:	C/CS mount with adaptor
Lens Drive Type:	Auto iris (DC)
Number of Privacy Zones:	15
High Speed Shutter:	1/50 ~ 1/10.000 sec, auto
BLC: Back Light:	BLC / HLC / off
AGC:	6~44.8dB
Digital Noise Reduction (DNR):	On/Off (1~6 level)
Additional Features:	H Reverse, High Light Compensation
Motion Detection:	On/Off
OSD:	Yes (DE,EN,FR,ES,RU,PR,JP)
Camera ID:	52 character over 2 lines
White Balance:	ATW/PUSH/Anti CR/Manual/User 1/User 2
Video Outputs:	1 CVBS (1Vpp), BNC
Humidity:	less than 90%, non condensing
Operating Temperature:	-25°C ~ +55°C
Supply Voltage:	100 ~ 240 VAC, 50/60Hz
Power Consumption:	3 W
Weight:	0.33 kg
Dimensions (WxHxD):	69 x 55 x 120.5 mm

DIMENSIONS (MM)

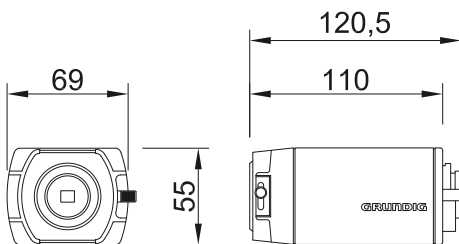

ACCESSORIES

GBR-WA03





GCA-B1005B

1/3" CCD Colour/B&W Camera, 700TVL, WDR, 230VAC

- Digital Noise Reduction (DNR), Digital Image Stabilization (DIS), On Screen Menu (OSD), Privacy Zone Masking, Remote Control Interface, H/V-Reverse
- 650 TV Lines (colour), 700 TV Lines (B/W) excellent high horizontal resolution
- High Sensitivity of 0,001 Lux
- WDR function, Colour/B&W function with removable IR cut filter
- High Light Compensation (Conversion of peaklight into greyscale)
- Power Input AC 100 - 240V



SPECIFICATIONS

Image Sensor:	1/3" CCD Sony 960H Super HAD II, Dual Shutter
Scanning System:	PAL, 50Hz, 2:1 Inter Line Transfer
Pixels - Effective:	976(H) x 582(V)
Resolution:	650 (H) lines colour, 700 (H) lines b&w
Col/B&W:	On/Off/Auto/Ext, IR-cut filter removable (ICR)
Sensitivity Colour:	0.01 Lux (50IRE) @ F1.2
Sensitivity B&W:	0.001 Lux (50IRE) @ F1.2
S/N Ratio:	>52dB (AGC off)
Lens Mount:	C/CS mount with adaptor
Lens Drive Type:	Auto iris (DC)
Sens Up:	Off ~ x512, auto
Motion Detection:	On/Off
Number of Privacy Zones:	15
Wide Dynamic Range:	low, medium, high
High Speed Shutter:	1/50 ~ 1/10.000 sec, auto
BLC: Back Light:	BLC / HLC / off
AGC:	6~44.8dB
Digital Noise Reduction (DNR):	On/Off (1~6 level)
Digital Image Stabilization (DIS):	Off/On
Additional Features:	H/V Reverse, High Light Compensation, E-Zoom
OSD:	Yes (DE,EN,FR, ES, PR, PL,RU)
Camera ID:	52 character over 2 lines
White Balance:	ATW/PUSH/Anti CR/Manual/User 1/User 2
Remote Control:	Coaxitron, data on coax cable
Video Outputs:	1 CVBS (1Vpp), BNC
Humidity:	less than 90%, non condensing
Operating Temperature:	-25°C ~ +55°C
Supply Voltage:	100 ~ 240 VAC, 50/60Hz
Power Consumption:	3 W
Weight:	0.33 kg
Dimensions (WxHxD):	69 x 55 x 120.5 mm

DIMENSIONS (MM)

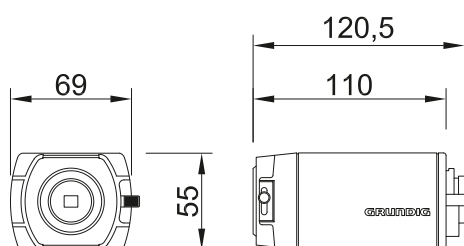

ACCESSORIES

GBR-WA03





GCA-B1302B

1/3" CCD Colour Box Camera, 650TVL, 12VDC/24VAC

- 650 TV Lines excellent high horizontal resolution
- High Sensitivity of 0,01 Lux
- High Light Compensation (Conversion of peaklight into grey-scale)
- ATR (Adaptive Tone-curve Reproduction) Pixel-to pixel based tone-curve correction optimizes the contrast of image similar to WDR. ATR mode makes low luminance area brighter and high luminance area darker.
- Power input AC24V/DC12V



SPECIFICATIONS

Image Sensor:	1/3" CCD Sony 960H Ex-view HAD II
Scanning System:	PAL, 50Hz, 625L (V), 2:1 Inter Line Transfer
Pixels - Effective:	976(H) x 582(V)
Resolution:	650 (H) lines
Col/B&W:	Auto (Electronic) / Color / B/W / External
Sensitivity Colour:	0.01 Lux (50IRE) @ F1.2
S/N Ratio:	>52dB [AGC off]
Lens Mount:	C/CS mount with adaptor
Lens Drive Type:	Auto iris (DC)
Number of Privacy Zones:	15
High Speed Shutter:	1/50 ~ 1/10.000 sec, auto
BLC: Back Light:	BLC / HLC / off
AGC:	Off, On (x0.25/x0.5/x0.75/x1)
Digital Noise Reduction (DNR):	Off, On 2D
Additional Features:	H Reverse, High Light Compensation
Motion Detection:	On/Off (4 Zones)
OSD:	Yes (DE,EN,FR,ES,PR,RU,JP)
Camera ID:	52 character over 2 lines
White Balance:	ATW/Push/User1/User2/AntiCR/Manual/Push Lock
Video Outputs:	1 CVBS (1Vpp), BNC
Humidity:	less than 90%, non condensing
Operating Temperature:	-25°C ~ +55°C
Supply Voltage:	12 VDC / 24 VAC
Power Consumption:	3 W
Weight:	0.23 kg
Dimensions (WxHxD):	69 x 55 x 120.5 mm

DIMENSIONS (MM)

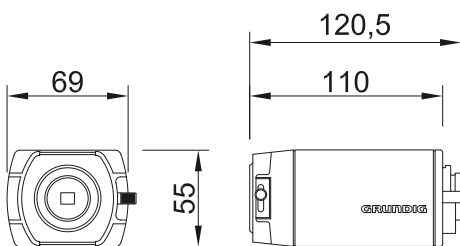

ACCESSORIES

GBR-WA03





GCA-B1305B

1/3" CCD Colour/B&W Camera, 700TVL, WDR,
12VDC/24VAC

- Digital Noise Reduction (DNR), Digital Image Stabilization (DIS), On Screen Menu (OSD), Privacy Zone Masking, Remote Control Interface, H/V-Reverse
- 650 TV Lines (colour), 700 TV Lines (B/W) excellent high horizontal resolution
- High Sensitivity of 0,001 Lux
- WDR function, Colour/B&W function with removable IR cut filter
- High Light Compensation (Conversion of peaklight into grey-scale)
- Power input AC24V/DC12V



SPECIFICATIONS

Image Sensor:	1/3" CCD Sony 960H Super HAD II, Dual Shutter
Scanning System:	PAL, 50Hz, 625L (V), 2:1 Inter Line Transfer
Pixels - Effective:	976(H) x 582(V)
Resolution:	650 (H) lines colour, 700 (H) lines b&w
Col/B&W:	On/Off/Auto/Ext, IR-cut filter removable (ICR)
Sensitivity Colour:	0.01 Lux (50IRE) @ F1.2
Sensitivity B&W:	0.001 Lux (50IRE) @ F1.2
S/N Ratio:	>52dB (AGC off)
Lens Mount:	C/CS mount with adaptor
Lens Drive Type:	Auto iris (DC)
Sens Up:	Off ~ x512, auto
Motion Detection:	On/Off
Number of Privacy Zones:	15
Wide Dynamic Range:	Normal / Light / Full
High Speed Shutter:	1/50 ~ 1/10.000 sec, auto
BLC: Back Light:	BLC / HLC / off
AGC:	6~44.8dB
Digital Noise Reduction (DNR):	On/Off (1~6 level)
Digital Image Stabilization (DIS):	Off/On
Additional Features:	H/V Reverse, High Light Compensation, E-Zoom
OSD:	Yes (DE, EN, FR, ES, PR, RU, JP)
Camera ID:	52 character over 2 lines
White Balance:	ATW/PUSH/Anti CR/Manual/User 1/User 2
Remote Control:	Coaxitron, data on coax cable
Video Outputs:	1 CVBS (1Vpp), BNC
Humidity:	less than 90%, non condensing
Operating Temperature:	-25°C ~ +55°C
Supply Voltage:	12 VDC / 24 VAC
Power Consumption:	3 W
Weight:	0.33 kg
Dimensions (WxHxD):	69 x 55 x 120.5 mm

DIMENSIONS (MM)

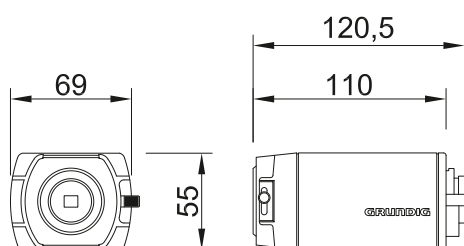

ACCESSORIES

GBR-WA03





GCA-H0325D

1.3 Megapixel HD Fixdome Camera 2.8~12mm ICR WDR IR 28 LED

- 1.3 Megapixel Sony® Exmor™ sensor with 1000 TVL highest resolution (analogue) and superior low light performance
- 3x to digital zoom without loss of resolution
- Tampering detection shows text in the image “Anti Blocking” or “Anti Shifting”
- Intelligent Video Content Analysis with Motion Tracking
- Smart IR LED Control with adjustable level
- 3 Axis Gimbal, to mount on Wall or Ceiling
- Remote Control Interfaces over Coax (Coaxitron)
- Built-in Service Monitor Port & OSD Control Port
- Support Dual Power AC24V/DC12V

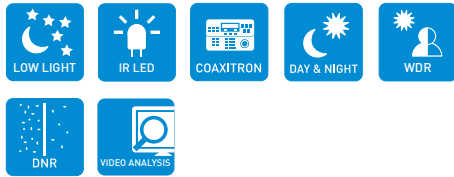

DIMENSIONS (MM)

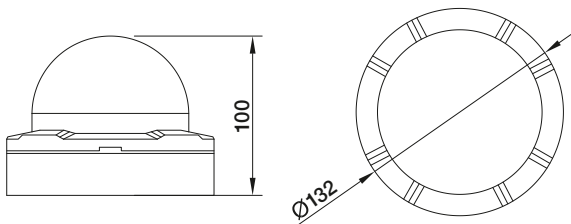

ACCESSORIES

GBR-WA06

GBR-IC06

GKB-A0040P



SPECIFICATIONS

Image Sensor:	1/3" CMOS Sony Exmor® , 1.3 Megapixel
Scanning System:	PAL, 50Hz or NTSC, 60 HZ, selectable
Pixels - Effective:	1302(H) x 1049(V), 1.3 Megapixels
Resolution:	650 (H) lines colour, 700 (H) lines b&w
Col/B&W:	Auto, Color, Removable IR-Cut Filter (ICR)
Sensitivity Colour:	0.4 Lux[50IRE] @ F1.2 (SensUp=0, AGC Off), 0.000007Lux 15IRE @ F1.2(SensUpx512)
Sensitivity B&W:	0 Lux LED IR on
High Speed Shutter:	1/50 ~ 1/60.000 sec, auto, Antiflicker
S/N Ratio:	>50dB (AGC off)
Lens Focal Length:	2.8 ~ 12 mm
Viewing Angle:	(H)98.8°~28.8° /(V)71.1°~21.6°
Lens Drive Type:	Auto iris (DC)
Iris F-Number:	F= 1.2 ~ 360
Sens Up:	Off ~ x32, auto
AGC:	0~20 adjustable, 20=default
WDR:	Off/Low/Middle/High
De-Fog:	Off/On Area Setting
BLC: Back Light:	On/Off/HLC
White Balance:	ATW/Push/User1/User2/AntiCR/Manual/Push Lock
Digital Noise Reduction (DNR):	3D-DNR : Off/Low/Mid/High
Digital Zoom:	Off ~ 8x
Motion Detection:	On/ Off/ Sensitivity/ 4 Area setting
Number of Privacy Zones:	16 programmable zones
Intelligent Video Analytics:	Scene change detection, masking of the camera lens
Tampering Alarm:	On/Off
On Screen Alarm Information:	On camera shaking: "Unknown Motion", on brightness change "Blocking!!"
Motion Tracking (Quick Zoom):	On/Off
Lens Shading Compensation:	On/Off
Reverse:	Off/ H-REV/ V-REV/ HV-REV
Camera ID:	52 character over 2 lines
OSD:	Yes, E/D/F/I
Profile Presets:	Indoor, Outdoor, Elevator, Lobby, Low, High, Hallway
IR LED:	28 pcs.
Optical Wavelength:	850 nm
Max. IR Distance:	15/30 m [according to scene reflexion]
Alarm Output:	1
Remote Control:	Coaxitron, data on coax cable
Video Outputs:	1 Ch Composite BNC, 1 Test monitor 2-pin connector
Accessories included:	Multi-Language Manual, Template, Cable for Service Monitor, Screws, screw driver for Zoom and Focus adjustment
Humidity:	less than 90%, non condensing
Operating Temperature:	-25°C ~ +55°C
Supply Voltage:	12 VDC / 24 VAC
Power Consumption:	6 (LED on) W
Weight:	0,37 kg
Dimensions (WxHxD):	Ø 132 x 100 mm



GCA-B4322D

1/3" CCD Fixed Dome Camera 2.8~12mm
SOFT D/N 650L

- Varifocal Lens: f = 2.8 - 12 mm, auto iris
- Fast & easy Zoom/Focus adjustment mechanic
- 3 Axis Gimbal, to mount on Wall or Ceiling
- Built-in Service Monitor Port & OSD Control Port
- Video Enhancement: ATR, BLC, HLC, DNR
- Support Dual Power AC24V/DC12V



DIMENSIONS (MM)

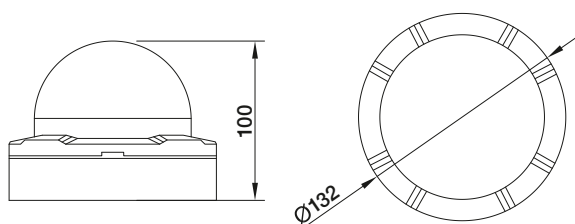

SPECIFICATIONS

Image Sensor:	1/3" CCD Sony 960H Ex-view HAD II
Scanning System:	PAL, 50Hz, 625L (V), 2:1 Inter Line Transfer
Pixels - Effective:	976(H) x 582(V)
Resolution:	650 (H) lines
Col/B&W:	Auto (fixed IR-Cut filter)
Sensitivity Colour:	0.8 Lux (50IRE) @ F1.4
Sensitivity B&W:	0.8 Lux (50IRE) @ F1.4
High Speed Shutter:	1/50 ~ 1/10.000 sec, auto
S/N Ratio:	>50 dB
Lens Focal Length:	2.8 ~ 12 mm
Viewing Angle:	97° ~ 24°
Lens Drive Type:	Auto iris (DC)
Iris F-Number:	F= 1.4 ~ 360
Motion Detection:	On/Off (4 Zones)
Number of Privacy Zones:	15
BLC: Back Light:	BLC / HLC / off
ATR (Adaptive Tone Reproduction):	On/Off
AGC:	6~44.8dB
Digital Noise Reduction (DNR):	On/Off (1~6 level)
OSD:	Yes (DE,EN,FR,ES,PR,PL,RU)
Camera ID:	52 character over 2 lines
White Balance:	ATW/Push/User1/User2/AntiCR/Manual/Push Lock
Video Outputs:	1 CVBS 1 Vpp (BNC) & 1 test monitor out
Humidity:	less than 90%, non condensing
Accessories included:	Multi-Language Manual, Template, Cable for Service Monitor, Screws, screw driver for Zoom and Focus adjustment
Operating Temperature:	-25°C ~ +55°C
Supply Voltage:	12 VDC / 24 VAC
Power Consumption:	1.7 W
Weight:	0.32 kg
Dimensions (WxHxD):	Ø 132 x 100 mm

ACCESSORIES

GBR-WA06



GBR-IC06



GKB-A0040P





GCA-B4326D

1/3" CCD Fixed Dome Camera 2.8~12mm ICR 28 IR LED 700L

- Varifocal Lens: f = 2.8 - 12 mm, auto iris
- High Sensitivity of 0,1 Lux
- 700 TV Lines (colour), 750 TV Lines (B/W) excellent high horizontal resolution
- Removable IR CUT Filter (ICR) for high IR sensitivity at night mode
- Smart IR LED Control with adjustable level
- Fast & easy Zoom/Focus adjustment mechanic
- 3 Axis Gimbal, to mount on Wall or Ceiling
- Built-in Service Monitor Port & OSD Control Port
- Support Dual Power AC24V/DC12V



DIMENSIONS (MM)

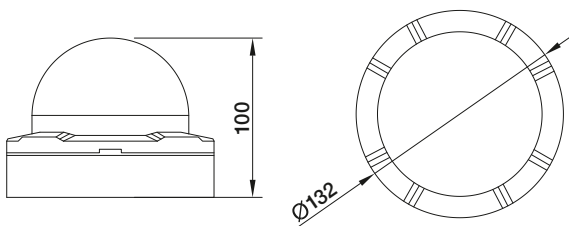

SPECIFICATIONS

Image Sensor:	1/3" CCD Sony 960H Ex-view HAD II
Scanning System:	PAL, 50Hz, 625L (V), 2:1 Inter Line Transfer
Pixels - Effective:	976(H) x 582(V)
Resolution:	650 (H) lines colour, 700 (H) lines b&w
Col/B&W:	Auto, Color, Removable IR-Cut Filter (ICR)
Sensitivity Colour:	0.8 lux(50IRE)@F1.4 (SensUp=0, AGC Off)
Sensitivity B&W:	0 Lux LED IR on
High Speed Shutter:	1/50 ~ 1/10.000 sec, auto
S/N Ratio:	>52dB (AGC off)
Lens Focal Length:	2.8 ~ 12 mm
Viewing Angle:	97° ~ 24°
Lens Drive Type:	Auto iris (DC)
Iris F-Number:	F= 1.4 ~ 360
Motion Detection:	On/ Off/ Sensitivity/ 4 Area setting
Number of Privacy Zones:	15
BLC: Back Light:	BLC / HLC / off
AGC:	6~44.8dB
Digital Noise Reduction (DNR):	On/Off (1~6 level)
OSD:	Yes (DE,EN,FR,ES,PR,PL,RU)
Camera ID:	52 character over 2 lines
White Balance:	ATW/Push/User1/User2/AntiCR/Manual/Push Lock
IR LED:	28 pcs.
Optical Wavelength:	850 nm
Max. IR Distance:	15/25 m [according to scene reflexion]
Video Outputs:	1 CVBS 1 Vpp (BNC) & 1 test monitor out
Remote Control:	Coaxitron, data on coax cable
Video Outputs:	1 Ch Composite BNC & 1 Test monitor out
Accessories included:	Multi-Language Manual, Template, Cable for Service Monitor, Screws, screw driver for Zoom and Focus adjustment
Humidity:	less than 90%, non condensing
Operating Temperature:	-25°C ~ +55°C
Supply Voltage:	12 VDC / 24 VAC
Power Consumption:	6 (LED on) W
Weight:	0,37 kg
Dimensions (WxHxD):	Ø 132 x 100 mm

ACCESSORIES

GBR-WA06



GBR-IC06



GKB-A0040P





GCA-B4325D

1/3" CCD Fixed Dome Camera 2.8~10.5mm ICR WDR 700L

- WDR (Wide Dynamic Range) for extreme backlight situations
- Removable IR CUT Filter (ICR) for high IR sensitivity at night mode
- TAMRON Varifocal Lens: $f = 2.8 - 10.5$ mm, auto iris
- Fast & easy Zoom/Focus adjustment mechanic
- 3 Axis Gimbal, to mount on wall or ceiling
- Remote Control Interfaces over Coax (Coaxitron)
- 15 polygonal Privacy Zone Masking
- Support Dual Power AC24V/DC12V



DIMENSIONS (MM)

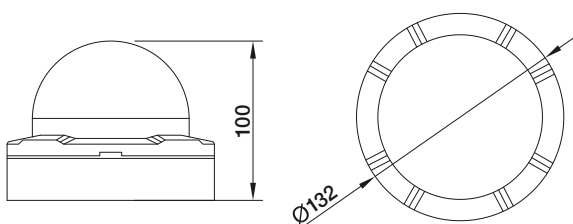

ACCESSORIES

GBR-WA06



GBR-IC06



GKB-A0040P



SPECIFICATIONS

Image Sensor:	1/3" CCD Sony 960H Super HAD II, Dual Shutter
Scanning System:	PAL, 50Hz, 2:1 Interlace, double scan
Pixels - Effective:	976(H) x 582(V)
Resolution:	650 (H) lines colour, 700 (H) lines b&w
Col/B&W:	Auto, Color, Removable IR-Cut Filter (ICR)
Sensitivity Colour:	0.7 lux 50IRE @ F1.2 (SensUp=0, AGC off), 0,00001 lux 15IRE @ F1.2 (SensUp=x512)
Sensitivity B&W:	0.5 lux 50IRE @ F1.2 (SensUp=0, AGC off), 0lux 15IRE @ F1.2 (SensUpx512)
High Speed Shutter:	1/50 ~ 1/10.000 sec, auto
S/N Ratio:	>52 dB
Lens Focal Length:	2.8 ~ 10.5 mm (TAMRON)
Viewing Angle:	102° ~ 27°
Lens Drive Type:	Auto iris (DC)
Iris F-Number:	F = 1.2 ~ 360
Sens Up:	Off ~ x512, auto
Motion Detection:	On/ Off/ Sensitivity/ 4 Area setting
Number of Privacy Zones:	15 (polygonal method)
WDR:	Off/On/Low/Midlow/Mid/Midhigh/High
AGC:	Off/ On (Very LOW/ LOW/ Mid /High /Very High/ User/ Fix)
BLC: Back Light:	BLC / HLC / off
Digital Noise Reduction (DNR):	Low/Midlow/Mid/Midhigh/High/Off (2D/3D)
Digital Image Stabilization (DIS):	Off/On
Digital Zoom:	Off/1 ~ 16x
Reverse:	Off/ H-REV/ V-REV/ HV-REV
OSD:	Yes (DE,EN,FR,IT,RU,TR)
Camera ID:	52 character over 2 lines
White Balance:	ATW/Push/User1/User2/AntiCR/Manual/Push Lock
Remote Control:	Coaxitron, data on coax cable
Video Outputs:	1 CVBS 1 Vpp (BNC) & 1 test monitor out
Accessories included:	Multi-Language Manual, Template, Cable for Service Monitor, Screws, screw driver for Zoom and Focus adjustment
Humidity:	less than 95%, non condensing
Operating Temperature:	-25°C ~ +55°C
Supply Voltage:	12 VDC / 24 VAC
Power Consumption:	2.2 W
Weight:	0.32 kg
Dimensions (WxHxD):	Ø 132 x 100 mm



GCA-B4327D

1/3" CCD Fixed Dome Camera 2.8~10.5mm ICR 28 IR LED WDR 700L

- WDR function, Colour/B&W function with removable IR cut filter
- Smart IR LED Control with adjustable level
- TAMRON Varifocal Lens: f = 2.8 - 10.5 mm, auto iris
- Fast & easy Zoom/Focus adjustment mechanic
- 3 Axis Gimbal, to mount on Wall or Ceiling
- Remote Control Interfaces over Coax (Coaxitron)
- 15 polygonal Privacy Zone Masking
- Support Dual Power AC24V/DC12V
- Extended Temperature range -25°C ~ +55°C



DIMENSIONS (MM)

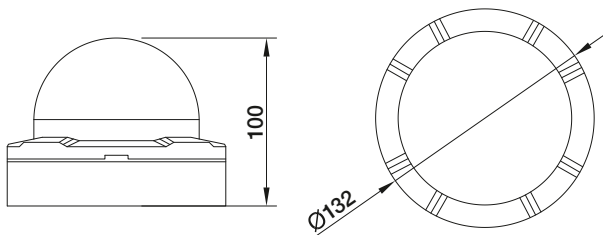

SPECIFICATIONS

Image Sensor:	1/3" CCD Sony 960H Super HAD II, Dual Shutter
Scanning System:	PAL, 50Hz, 2:1 Interlace, double scan
Pixels - Effective:	976(H) x 582(V)
Resolution:	650 (H) lines colour, 700 (H) lines b&w
Col/B&W:	Auto, Color, Removable IR-Cut Filter (ICR)
Sensitivity Colour:	0.4 Lux[50IRE] @ F1.2 (SensUp=0, AGC Off), 0.000007Lux 15IRE @ F1.2(SensUp=512)
Sensitivity B&W:	0 Lux LED IR on
High Speed Shutter:	1/50 ~ 1/10.000 sec, auto
S/N Ratio:	>52 dB
Lens Focal Length:	2.8 ~ 10.5 mm (TAMRON)
Viewing Angle:	102° ~ 27°
Lens Drive Type:	Auto iris (DC)
Iris F-Number:	F= 1.2 ~ 360
Sens Up:	Off ~ x512, auto
Motion Detection:	On/ Off/ Sensitivity/ 4 Area setting
Number of Privacy Zones:	15 [polygonal method]
AGC:	Off, On (x0.25/x0.5/x0.75/x1)
WDR:	Off/On/Low/Midlow/Mid/Midhigh/High
BLC: Back Light:	On/Off/HLC
Digital Noise Reduction (DNR):	Low/Midlow/Mid/Midhigh/High/Off (2D/3D)
Digital Image Stabilization (DIS):	Off/On
Digital Zoom:	Off/1 ~ 16x
Reverse:	Off/ H-REV/ V-REV/ HV-REV
OSD:	Yes (DE,EN,FR,ES,PR,PL,RU)
Camera ID:	52 character over 2 lines
White Balance:	ATW/Push/User1/User2/AntiCR/Manual/Push Lock
IR LED:	28 pcs.
Optical Wavelength:	850 nm
Max. IR Distance:	20/40 m (according to scene reflexion)
Remote Control:	Coaxitron, data on coax cable
Video Outputs:	1 CVBS 1 Vpp (BNC) & 1 test monitor out
Accessories included:	Multi-Language Manual, Template, Cable for Service Monitor, Screws, screw driver for Zoom and Focus adjustment
Humidity:	less than 90%, non condensing
Operating Temperature:	-25°C ~ +55°C
Supply Voltage:	12 VDC / 24 VAC
Power Consumption:	6 (LED on) W
Weight:	0,37 kg
Dimensions (WxHxD):	Ø 132 x 100 mm

ACCESSORIES

GBR-WA06



GBR-IC06



GKB-A0040P





GCA-H0325V

1.3 Megapixel HD Fixdome Camera 2.8~12mm ICR WDR IR 28 LED

- 1.3 Megapixel Sony® Exmor™ sensor with 1000 TVL highest resolution (analog) and superior low light performance
- Tampering detection shows text in the image “Anti Blocking” or “Anti Shifting”
- Intelligent Video Content Analysis with Motion Tracking
- Vandal Resistant Dome (IK10)
- Smart IR LED Control with adjustable level
- 3 Axis Gimbal, 2 ways to mount: Wall/Ceiling Flat and Flush
- Remote Control Interfaces over Coax (Coaxitron)
- Fast & easy Zoom/Focus adjustment mechanic
- Built-in Service Monitor Port & OSD Control Port
- Support Dual Power AC24V/DC12V
- Extended Temperature range -25°C ~ +55°C



DIMENSIONS (MM)

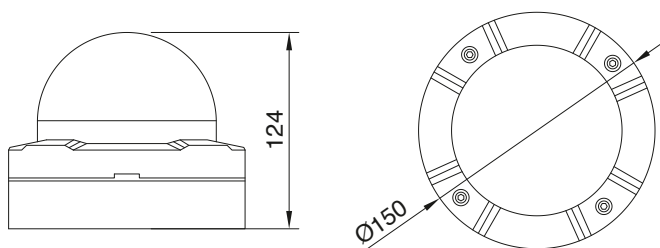

ACCESSORIES

GBR-WA04



GBR-CE02



GBR-WB02



GBR-PM02



GKB-A0040P



GBR-IC04



SPECIFICATIONS

Image Sensor:	1/3" CMOS Sony Exmor®, 1.3 Megapixel
Scanning System:	PAL, 50Hz or NTSC, 60 HZ, selectable
Pixels - Effective:	1302(H) x 1049(V), 1.3 Megapixels
Resolution:	650 (H) lines colour, 700 (H) lines b&w
Col/B&W:	Auto, Color, Removable IR-Cut Filter (ICR)
Sensitivity Colour:	0.4 Lux(50IRE) @ F1.2 (SensUp=0, AGC Off), 0.000007Lux 15IRE @ F1.2(SensUp=512)
Sensitivity B&W:	0 Lux LED IR on
High Speed Shutter:	1/50 ~ 1/60,000 sec, auto, Antiflicker
S/N Ratio:	>50dB (AGC off)
Lens Focal Length:	2.8 ~ 12 mm
Viewing Angle:	102° ~ 27°
Lens Drive Type:	Auto iris (DC)
Iris F-Number:	F= 1.2 ~ 360
Sens Up:	Off ~ x32, auto
AGC:	0~20 adjustable, 20=default
WDR:	Off/Low/Middle/High
De-Fog:	Off/On Area Setting
BLC: Back Light:	On/Off/HLC
White Balance:	ATW/Push/User1/User2/AntiCR/Manual/Push Lock
Digital Noise Reduction [DNR]:	3D-DNR : Off/Low/Mid/High
Digital Zoom:	Off ~ 8x
Motion Detection:	On/ Off/ Sensitivity/ 4 Area setting
Number of Privacy Zones:	16 programmable zones
Intelligent Video Analytics:	Scene change detection, masking of the camera lens
Tampering Alarm:	On/Off
On Screen Alarm Information:	On camera shaking: "Unknown Motion", on brightness change "Blocking!!"
Motion Tracking (Quick Zoom):	On/Off
Lens Shading Compensation:	On/Off
Reverse:	Off/ H-REV/ V-REV/ HV-REV
Camera ID:	52 character over 2 lines
OSD:	Yes, E/D/F/I
Profile Presets:	Indoor, Outdoor, Elevator, Lobby, Low, High, Hallway
IR LED:	28 pcs.
Optical Wavelength:	850 nm
Max. IR Distance:	15/30 m (according to scene reflexion)
Alarm Outputs:	1
Remote Control:	Coaxitron, data on coax cable
Video Outputs:	1 Ch Composite BNC, 1 Test monitor 2-pin connector
Accessories included:	Multi-Language Manual, Template, Cable for Service Monitor, Screws, screw driver for Zoom and Focus adjustment
Protection Rating:	IP67/IK10
Humidity:	less than 90%, non condensing
Operating Temperature:	-25°C ~ +55°C
Supply Voltage:	12 VDC / 24 VAC
Power Consumption:	6 (LED on) W
Weight:	1.03 kg
Dimensions (WxHxD):	Ø 150 x 124 mm



GCA-B4323V

1/3" CCD VF Dome Camera 2.8-12mm ICR 700L

- Vandal Resistant Dome (IK10)
- Removable IR CUT Filter (ICR) for high IR sensitivity at night mode
- High Sensitivity of 0,1 Lux
- Varifocal Lens: f = 2.8 - 12 mm, auto iris
- Fast & easy Zoom/Focus adjustment mechanic
- 3 Axis Gimbal, 2 ways to mount: Wall/Ceiling Flat and Flush
- 650 TV Lines (colour), 700 TV Lines (B/W) excellent high horizontal resolution
- Built-in Service Monitor Port & OSD Control Port
- Remote Control Interfaces over Coax (Coaxitron)
- Extended Temperature range -25°C ~ +55°C
- Support Dual Power AC24V/DC12V



DIMENSIONS (MM)

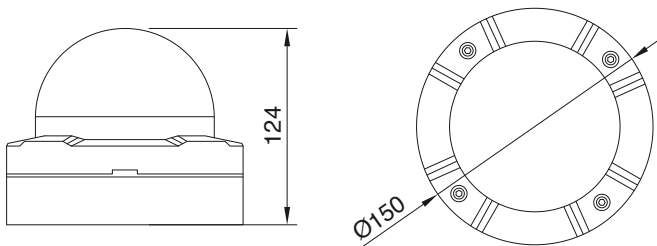

SPECIFICATIONS

Image Sensor:	1/3" CCD Sony 960H Ex-view HAD II
Scanning System:	PAL, 50Hz, 625L (V), 2:1 Inter Line Transfer
Pixels - Effective:	976(H) x 582(V)
Resolution:	650 (H) lines colour, 700 (H) lines b&w
Col/B&W:	Auto, Color, Removable IR-Cut Filter (ICR)
Sensitivity Colour:	0.8 lux(50IRE)@F1.4 (SensUp=0, AGC Off)
Sensitivity B&W:	0.6 Lux(50IRE) @ F1.4 (SensUp=0, AGC Off)
High Speed Shutter:	1/50 - 1/10.000 sec, auto
S/N Ratio:	>52dB (AGC off)
Lens Focal Length:	2.8 - 12 mm
Viewing Angle:	97° ~ 24°
Lens Drive Type:	Auto iris (DC)
Iris F-Number:	F= 1.4 ~ 360
Motion Detection:	On/Off (4 Zones)
Number of Privacy Zones:	15
BLC: Back Light:	BLC / HLC / off
AGC:	Off, On (x0.25/x0.5/x0.75/x1)
ATR (Adaptive Tone Reproduction):	On/Off
Digital Noise Reduction (DNR):	Off, On 2D
OSD:	Yes (DE,EN,FR,ES,PR,PL,RU)
Camera ID:	52 character over 2 lines
White Balance:	ATW/Push/User1/User2/AntiCR/Manual/Push Lock
Protection Rating:	IP67 / IK10
Video Outputs:	1 CVBS 1 Vpp (BNC) & 1 test monitor out
Accessories included:	Multi-Language Manual, Template, Cable for Service Monitor, Screws, screw driver for Zoom and Focus adjustment
Humidity:	less than 90%, non condensing
Operating Temperature:	-25°C ~ +55°C
Supply Voltage:	12 VDC / 24 VAC
Power Consumption:	2.4 W
Weight:	1.1 kg
Dimensions (WxHxD):	Ø 150 x 124 mm

ACCESSORIES

GBR-WA04



GBR-CE02



GBR-WB02



GBR-PM02



GKB-A0040P



GBR-IC04





GCA-B4326V

1/3" CCD VF Dome 2Camera 2.8~12mm
ICR IR 28 LED 700L

- Vandal Resistant Dome (IK10)
- High Sensitivity of 0,1 Lux
- High Light Compensation (Conversion of peaklight into grey-scale)
- 650 TV Lines (colour), 700 TV Lines (B/W) excellent high horizontal resolution
- Varifocal Lens: f = 2.8 - 12 mm, auto iris
- Fast & easy Zoom/Focus adjustment mechanic
- 3 Axis Gimbal, 2 ways to mount: Wall/Ceiling Flat and Flush
- Built-in Service Monitor Port & OSD Control Port
- Extended Temperature range -25°C ~ +55°C
- Support Dual Power AC24V/DC12V



DIMENSIONS (MM)

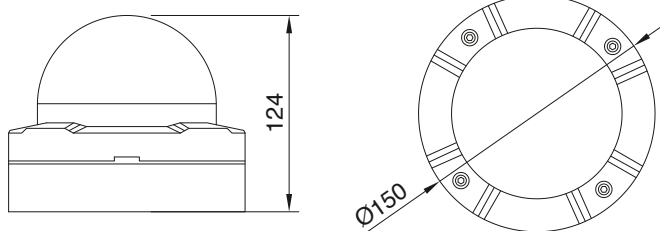

SPECIFICATIONS

Image Sensor:	1/3" CCD Sony 960H Ex-view HAD II
Scanning System:	PAL, 50Hz, 625L (V), 2:1 Inter Line Transfer
Pixels - Effective:	976(H) x 582(V)
Resolution:	650 (H) lines colour, 700 (H) lines b&w
Col/B&W:	Auto, Color, Removable IR-Cut Filter (ICR)
Sensitivity Colour:	0.8 lux(50IRE)@F1.4 (SensUp=0, AGC Off)
Sensitivity B&W:	0 Lux LED IR on
High Speed Shutter:	1/50 ~ 1/10.000 sec, auto
S/N Ratio:	>52dB (AGC off)
Lens Focal Length:	2.8 ~ 12 mm
Viewing Angle:	97° ~ 24°
Lens Drive Type:	Auto iris (DC)
Iris F-Number:	F= 1.4 ~ 360
Motion Detection:	On/Off
Number of Privacy Zones:	15 (polygonal method)
BLC: Back Light:	BLC / HLC / off
AGC:	6~44.8dB
Digital Noise Reduction (DNR):	On/Off (1~6 level)
OSD:	Yes (DE,EN,FR,IT,RU,TR)
Camera ID:	52 character over 2 lines
White Balance:	ATW/Push/User1/User2/AntiCR/Manual/Push Lock
IR LED:	28 pcs.
Optical Wavelength:	850 nm
Max. IR Distance:	15/30 m [according to scene reflexion]
Protection Rating:	IP67 / IK10
Video Outputs:	1 CVBS 1 Vpp (BNC) & 1 test monitor out
Accessories included:	Multi-Language Manual, Template, Cable for Service Monitor, Screws, screw driver for Zoom and Focus adjustment
Humidity:	less than 90%, non condensing
Operating Temperature:	-25°C ~ +55°C
Supply Voltage:	12 VDC / 24 VAC
Power Consumption:	2.4 (5.8 LED on) W
Weight:	1.1 kg
Dimensions (WxHxD):	Ø 150 x 124 mm

ACCESSORIES

GBR-WA04



GBR-CE02



GBR-WB02



GBR-PM02



GKB-A0040P



GBR-IC04





GCA-B4325V

1/3" CCD VF Dome Camera 2.8~10.5mm ICR WDR 700L

- Vandal Resistant Dome (IK10)
- WDR (Wide Dynamic Range) for extreme backlight situations
- TAMRON Varifocal Lens: f = 2.8 - 10.5 mm, auto iris
- 3 Axis Gimbal, to mount on Wall or Ceiling
- Fast & easy Zoom/Focus adjustment mechanic
- Remote Control Interfaces over Coax (Coaxitron)
- Extended Temperature range -25°C ~ +55°C
- Support Dual Power AC24V/DC12V



DIMENSIONS (MM)

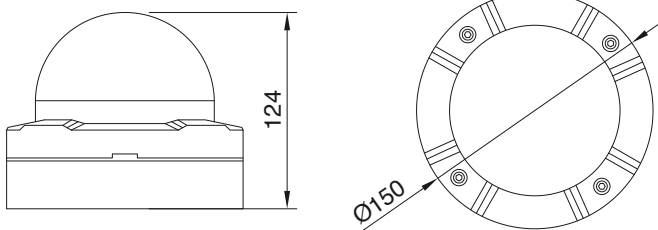

SPECIFICATIONS

Image Sensor:	1/3" CCD Sony 960H Super HAD II, Dual Shutter
Scanning System:	PAL, 50Hz, 2:1 Interlace
Pixels - Effective:	976(H) x 582(V)
Resolution:	650 (H) lines colour, 700 (H) lines b&w
Co/B&W:	Auto, Color, Removable IR-Cut Filter (ICR)
Sensitivity Colour:	0.7 lux 50IRE @ F1.2 [SensUp=0,AGC off], 0,00001 lux 15IRE @ F1.2[SensUp=x512]
Sensitivity B&W:	0 Lux LED IR on
S/N Ratio:	>52 dB
Lens Focal Length:	2.8 ~ 10.5 mm (TAMRON)
Viewing Angle:	102° ~ 27°
Lens Drive Type:	Auto iris [DC]
Iris F-Number:	F= 1.2 ~ 360
Sens Up:	Off ~ x512, auto
Motion Detection:	On/ Off/ Sensitivity/ 4 Area setting
Number of Privacy Zones:	15
High Speed Shutter:	1/50 ~ 1/10.000 sec, auto
AGC:	6~44,8dB
BLC: Back Light:	On/Off/HLC
WDR:	Off/Low/Middle/High
Digital Noise Reduction (DNR):	On/Off [1~6 level]
Digital Image Stabilization (DIS):	Off/On
Digital Zoom:	Off/1 ~ 16x
Reverse:	Off/ H-REV/ V-REV/ HV-REV
OSD:	Yes (DE,EN,FR,ES,PR,PL,RU)
Camera ID:	52 character over 2 lines
White Balance:	ATW/Push/User1/User2/AntiCR/Manual/Push Lock
Protection Rating:	IP67 / IK10
Remote Control:	Coaxitron, data on coax cable
Video Outputs:	1 CVBS 1 Vpp (BNC) & 1 test monitor out
Accessories included:	Multi-Language Manual, Template, Cable for Service Monitor, Screws, screw driver for Zoom and Focus adjustment
Humidity:	less than 90%, non condensing
Operating Temperature:	-25°C ~ +55°C
Supply Voltage:	12 VDC / 24 VAC
Power Consumption:	5.8 W
Weight:	1.02 kg
Dimensions (WxHxD):	Ø 150 x 124 mm

ACCESSORIES

GBR-WA04



GBR-CE02



GBR-WB02



GBR-PM02



GKB-A0040P



GBR-IC04





GCA-B5326V

1/3" CCD VF Dome Camera 2,8–10.5mm
ICR 28 IR LED 700L

- Vandal Resistant Dome (IK10)
- 3 Axis Gimbal, 2 ways to mount: Wall/Ceiling Flat and Flush
- TAMRON Varifocal Lens: $f = 2.8 - 10.5$ mm, auto iris
- Fast & easy Zoom/Focus adjustment mechanic
- Remote Control Interfaces over Coax (Coaxitron)
- Extended Temperature range $-25^{\circ}\text{C} \sim +55^{\circ}\text{C}$
- Support Dual Power AC24V/DC12V



DIMENSIONS (MM)

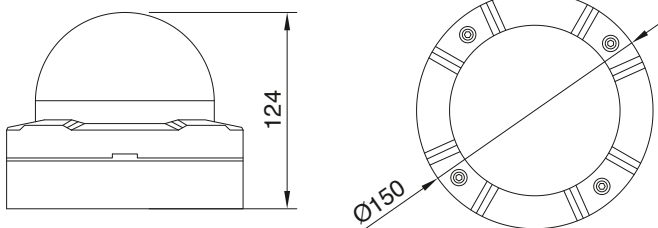

ACCESSORIES

GBR-WA04



GBR-CE02



GBR-WB02



GBR-PM02



GKB-A0040P



GBR-IC04



SPECIFICATIONS

Image Sensor:	1/3" CCD Sony 960H Ex-view HAD II
Scanning System:	PAL, 50Hz, 2:1 Interlace
Pixels - Effective:	976(H) x 582(V)
Resolution:	650 (H) lines colour, 700 (H) lines b&w
Col/B&W:	Auto, Color, Removable IR-Cut Filter (ICR)
Sensitivity Colour:	0.4 Lux(50IRE) @ F1.2 (SensUp=0, AGC Off), 0.000007Lux 15IRE @ F1.2(SensUpx512)
Sensitivity B&W:	0 Lux LED IR on
S/N Ratio:	>52 dB
Lens Focal Length:	2.8 ~ 10.5 mm (TAMRON)
Viewing Angle:	102° ~ 27°
Lens Drive Type:	Auto iris (DC)
Iris F-Number:	F= 1.2 ~ 360
Sens Up:	Off ~ x512, auto
Motion Detection:	On/ Off/ Sensitivity/ 4 Area setting
Number of Privacy Zones:	15
High Speed Shutter:	1/50 ~ 1/10.000 sec, auto
AGC:	6~44.8dB
ATR WDR:	On/Off
BLC: Back Light:	On/Off/HLC
Digital Noise Reduction (DNR):	On/Off [1~6 level]
Digital Image Stabilization (DIS):	Off/On
Reverse:	Off/ H-REV/ V-REV/ HV-REV
Digital Zoom:	Off/1 ~ 16x
OSD:	Yes (DE,EN,FR,IT,RU,TR)
Camera ID:	52 character over 2 lines
White Balance:	ATW/Push/User1/User2/AntiCR/Manual/Push Lock
IR LED:	28 pcs.
Optical Wavelength:	850 nm
Max. IR Distance:	15/30 m (according to scene reflexion)
Protection Rating:	IP67 / IK10
Remote Control:	Coaxitron, data on coax cable
Accessories included:	Multi-Language Manual, Template, Cable for Service Monitor, Screws, screw driver for Zoom and Focus adjustment
Humidity:	less than 90%, non condensing
Operating Temperature:	$-25^{\circ}\text{C} \sim +55^{\circ}\text{C}$
Supply Voltage:	12 VDC / 24 VAC
Power Consumption:	5.8 (LED on) W
Weight:	1.12 kg
Dimensions (WxHxD):	Ø 150 x 124 mm



GCA-B4327V

1/3" CCD VF Dome Camera 2.8~10.5mm
ICR 28 IR LED WDR 700L

- Vandal Resistant Dome (IK10)
- WDR (Wide Dynamic Range) for extreme backlight situations
- 3 Axis Gimbal, 2 ways to mount: Wall/Ceiling Flat and Flush
- TAMRON Varifocal Lens: f = 2.8 - 10.5 mm, auto iris
- Fast & easy Zoom/Focus adjustment mechanic
- Remote Control Interfaces over Coax (Coaxitron)
- Extended Temperature range -25°C ~ +55°C
- Support Dual Power AC24V/DC12V



DIMENSIONS (MM)

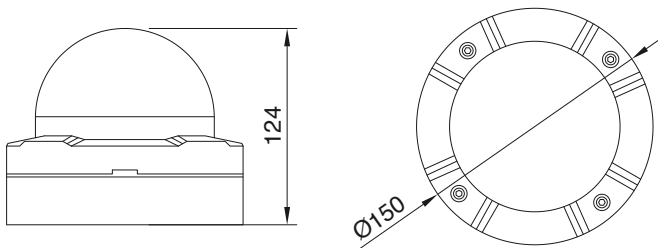

SPECIFICATIONS

Image Sensor:	1/3" CCD Sony 960H Super HAD II, Dual Shutter
Scanning System:	PAL, 50Hz, 2:1 Interlace
Pixels - Effective:	976(H) x 582(V)
Resolution:	650 (H) lines colour, 700 (H) lines b&w
Co/B&W:	Auto, Color, Removable IR-Cut Filter (ICR)
Sensitivity Colour:	0.7 lux 50IRE @ F1.2 (SensUp=0, AGC off), 0,00001 lux 15IRE @ F1.2(SensUp=x512)
Sensitivity B&W:	0.5 lux 50IRE @ F1.2 (SensUp=0, AGC off), 0lux 15IRE @ F1.2 (SensUpx512)
High Speed Shutter:	1/50 - 1/10.000 sec, auto
S/N Ratio:	>52 dB
Lens Focal Length:	2.8 - 10.5 mm (TAMRON)
Viewing Angle:	102° ~ 27°
Lens Drive Type:	Auto iris [DC]
Iris F-Number:	F= 1.2 - 360
Sens Up:	Off ~ x512, auto
Motion Detection:	On/ Off/ Sensitivity/ 4 Area setting
Number of Privacy Zones:	15
BLC: Back Light:	On/Off/HLC
WDR:	Off/Low/Middle/High
AGC:	6-44, 8dB
Digital Noise Reduction (DNR):	On/Off (1-6 level)
Digital Zoom:	Off/1 ~ 16x
Digital Image Stabilization (DIS):	Off/On
Reverse:	Off/ H-REV/ V-REV/ HV-REV
OSD:	Yes (DE, EN, FR, ES, PR, PL, RU)
Camera ID:	52 character over 2 lines
White Balance:	ATW/Push/User1/User2/AntiCR/Manual/Push Lock
IR LED:	28 pcs.
Optical Wavelength:	850 nm
Max. IR Distance:	15/30 m (according to scene reflexion)
Protection Rating:	IP67 / IK10
Remote Control:	Coaxitron, data on coax cable
Video Outputs:	1 CVBS 1 Vpp (BNC) & 1 test monitor out
Accessories included:	Multi-Language Manual, Template, Cable for Service Monitor, Screws, screw driver for Zoom and Focus adjustment
Humidity:	less than 90%, non condensing
Operating Temperature:	-25°C ~ +55°C
Supply Voltage:	12 VDC / 24 VAC
Power Consumption:	2.4 W
Weight:	1.12 kg
Dimensions (WxHxD):	Ø 150 x 124 mm

ACCESSORIES

GBR-WA04



GBR-CE02



GBR-WB02



GBR-PM02



GKB-A0040P



GBR-IC04





GCA-B5325V

1/3" CCD VF Dome Camera 9~22mm ICR WDR 700L

- Vandal Resistant Dome (IK10)
- WDR (Wide Dynamic Range) for extreme backlight situations
- Removable IR CUT Filter (ICR) for high IR sensitivity at night mode
- Varifocal Lens: f = 9 - 22 mm, auto iris
- Fast & easy Zoom/Focus adjustment mechanic
- 3 Axis Gimbal, 3 ways to mount: Wall/Ceiling Flat, Wall/Ceiling Angle and Flush
- Remote Control Interfaces over Coax (Coaxitron)
- Extended Temperature range -25°C ~ +55°C
- Support Dual Power AC24V/DC12V



DIMENSIONS (MM)

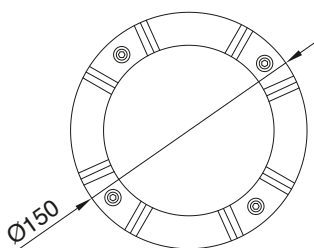
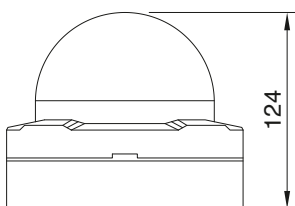

SPECIFICATIONS

Image Sensor:	1/3" CCD Sony 960H Super HAD II, Dual Shutter
Scanning System:	PAL, 50Hz, 2:1 Interlace
Pixels - Effective:	976(H) x 582(V)
Resolution:	650 (H) lines colour, 700 (H) lines b&w
Col/B&W:	Auto, Color, Removable IR-Cut Filter (ICR)
Sensitivity Colour:	0.8 lux[50IRE]@F1.8 [SensUp=0, AGC Off], 0.00001 lux 15IRE [SensUpx512] F1.8
Sensitivity B&W:	0.6 lux 50IRE @ F1.8 [SensUp=0, AGC off], 0lux 15IRE @ F1.8 [SensUpx512]
S/N Ratio:	>52 dB
Lens Focal Length:	9 ~ 22 mm
Viewing Angle:	31° ~ 14°
Lens Drive Type:	Auto iris (DC)
Iris F-Number:	F= 1.8 ~ 360
Sens Up:	Off ~ x512, auto
Motion Detection:	On/ Off/ Sensitivity/ 4 Area setting
Number of Privacy Zones:	15
High Speed Shutter:	1/50 ~ 1/10.000 sec, auto
BLC: Back Light:	On/Off/HLC
WDR:	Off/Low/Middle/High
AGC:	Off/ On (Very LOW/ LOW/ Mid /High /Very High/ User/ Fix)
Digital Noise Reduction (DNR):	Off / On (Low/Middle/High/User)
Digital Zoom:	Off/1 ~ 16x
Digital Image Stabilization (DIS):	Off/On
Reverse:	Off/ H-REV/ V-REV/ HV-REV
OSD:	Yes (DE,EN,FR,ES,PR,PL,RU)
Camera ID:	52 character over 2 lines
White Balance:	ATW/Push/User1/User2/AntiCR/Manual/Push Lock
Protection Rating:	IP66 / IK10
Remote Control:	Coaxitron, data on coax cable
Video Outputs:	1 CVBS 1 Vpp (BNC) & 1 test monitor out
Accessories included:	Multi-Language Manual, Template, Cable for Service Monitor, Screws, screw driver for Zoom and Focus adjustment
Humidity:	less than 90%, non condensing
Operating Temperature:	-25°C ~ +55°C
Supply Voltage:	12 VDC / 24 VAC
Power Consumption:	2.4 W
Weight:	1.12 kg
Dimensions (WxHxD):	Ø 150 x 124 mm

ACCESSORIES

GBR-WA04



GBR-CE02



GBR-WB02



GBR-PM02



GKB-A0040P



GBR-IC04





GCA-C2357V

1/4" CCD VF Dome Camera AFZ lens 3.8~38mm
ICR 28 IR LED 700L ext.adj

- Vandal Resistant Dome (IK10)
- Motorized Auto Focus Zoom lens 3,8 ~ 38 mm
- 0 Lux: Integrated LED IR Illuminator to see even in total darkness
- Built-in Service Monitor Port & OSD Control Port
- Concealed Cable Management
- F-DNR Fog Digital Noise Reduction
- Video Enhancement: BLC, HSBLIC, DNR
- Extended Temperature range -25°C ~ +55°C
- Support Dual Power AC24V/DC12V



DIMENSIONS (MM)

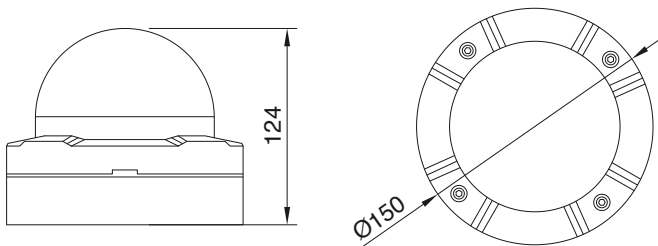

SPECIFICATIONS

Image Sensor:	1/4" CCD Sony 960H Ex-view HAD II
Scanning System:	PAL, 50Hz, 625L (V), 2:1 Inter Line Transfer
Pixels - Effective:	976(H) x 582(V)
Resolution:	650 (H) lines colour, 700 (H) lines b&w
Co/B&W:	Auto, Color, Removable IR-Cut Filter (ICR)
Sensitivity Colour:	0.9 lux(50IRE)@F1.8 (SensUp=0, AGC Off), 0.00001 lux 15IRE (SensUpx256) F1.8
Sensitivity B&W:	0 Lux LED IR on
Shutter Speed:	AUTO, OFF, FLK, 1/250, 1/500, 1/1000, 1/2000, 1/5000, 1/10000, 1/20000, 1/50000, 1/100000
S/N Ratio:	>52 dB
Lens Focal Length:	3.8 ~ 38 mm
Viewing Angle:	50°(W) ~ 5.5°(T)
Zoom Ratio:	x 10
Lens Drive Type:	Auto iris (DC)
Iris F-Number:	F= 1.8 ~ 360
Sens Up:	Off ~ x256, auto
BLC: Back Light:	BLC, HSBLIC, OFF, d-WDR
De-Fog:	Off/On
White Balance:	ATW, AWB, AWC-SET, MANUAL, INDOOR, OUTDOOR
Digital Noise Reduction (DNR):	OFF/ON/SMART (level 0-255)
Digital Zoom:	Off/1 ~ 12x
Motion Detection:	On/ Off/ Sensitivity/ 4 Area setting
Number of Privacy Zones:	8
Reverse:	Off/ H-REV/ V-REV/ HV-REV
Camera ID:	20 character
OSD:	Yes
Presettings:	CUSTOM, SPEED DOME, IR MODE, INDOOR, OUTDOOR, LOW LIGHT, HALL WAY
IR LED:	28 pcs.
Optical Wavelength:	850 nm
Max. IR Distance:	30/45 m (according to scene reflexion)
Serial Interface(s):	RS-485
Video Outputs:	1 CVBS 1 Vpp (BNC) & 1 test monitor out
Additional Features:	Image: Freeze, Negative
Accessories included:	Multi-Language Manual, Template, Cable for Service Monitor, Screws
Protection Rating:	IP66 / IK10
Humidity:	less than 90%, non condensing
Operating Temperature:	-25°C ~ +55°C
Supply Voltage:	12 VDC / 24 VAC
Power Consumption:	7.8 (LED on) W
Weight:	1.12 kg
Dimensions (WxHxD):	Ø 150 x 124 mm

ACCESSORIES

GBR-WA04



GBR-CE02



GBR-WB02



GBR-PM02



GKB-A0040P



GBR-IC04





GCA-H0325T

1.3 Megapixel HD Integrated Camera 2.8~12mm ICR WDR IR 42 LED

- 1.3 Megapixel Sony® Exmor™ sensor with 1000 TVL highest resolution (analog) and superior low light performance
- 3x to digital zoom without loss of resolution
- Tampering detection shows text in the image “Anti Blocking” or “Anti Shifting”
- Intelligent Video Content Analysis with Motion Tracking
- 3 Axis Gimbal, 2 ways to mount: Wall/Ceiling Flat and Flush
- Smart IR LED Control with adjustable level
- Remote Control Interfaces over Coax (Coaxitron)
- Built-in Service Monitor Port & OSD Control Port
- Support Dual Power AC24V/DC12V



DIMENSIONS (MM)

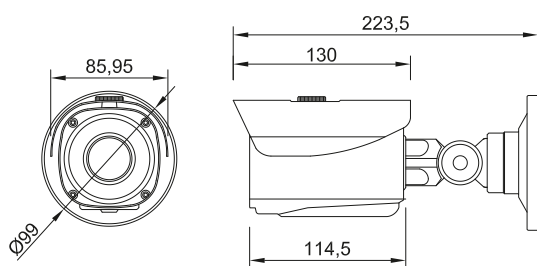

ACCESSORIES

GBR-FB03

GBR-PM02

GKB-A0040P



SPECIFICATIONS

Image Sensor:	1/3" CMOS Sony Exmor®, 1.3 Megapixel
Scanning System:	PAL, 50Hz or NTSC, 60 HZ, selectable
Pixels - Effective:	1302(H) x 1049(V), 1.3 Megapixels
Resolution:	1000 (H) lines
Col/B&W:	Auto, Color, Removable IR-Cut Filter (ICR)
Sensitivity Colour:	0.4 Lux[50IRE] @ F1.2 (SensUp=0, AGC Off), 0.000007Lux 15IRE @ F1.2(SensUpx512)
Sensitivity B&W:	0 Lux LED IR on
High Speed Shutter:	1/50 ~ 1/60.000 sec, auto, Antiflicker
S/N Ratio:	>50dB (AGC off)
Lens Focal Length:	2.8 ~ 12 mm
Viewing Angle:	102° ~ 27°
Lens Drive Type:	Auto iris (DC)
Iris F-Number:	F= 1.2 ~ 360
Sens Up:	Off ~ x32, auto
AGC:	0~20 adjustable, 20=default
WDR:	Off/Low/Middle/High
De-Fog:	Off/On Area Setting
BLC: Back Light:	On/Off/HLC
White Balance:	ATW/Push/User1/User2/AntiCR/Manual/Push Lock
Digital Noise Reduction (DNR):	3D-DNR : Off/Low/Mid/High
Digital Zoom:	Off ~ 8x
Motion Detection:	On/ Off/ Sensitivity/ 4 Area setting
Number of Privacy Zones:	16 programmable zones
Intelligent Video Analytics:	Scene change detection, masking of the camera lens
Tampering Alarm:	On/Off
On Screen Alarm Information:	On camera shaking: "Unknown Motion", on brightness change "Blocking!!"
Motion Tracking (Quick Zoom):	On/Off
Lens Shading Compensation:	On/Off
Reverse:	Off/ H-REV/ V-REV/ HV-REV
Camera ID:	52 character over 2 lines
OSD:	Yes, E/D/F/I
Profile Presets:	Indoor, Outdoor, Elevator, Lobby, Low, High, Hallway
IR LED:	42 pcs.
Optical Wavelength:	850 nm
Max. IR Distance:	45/70 m [according to scene reflexion]
Alarm Outputs:	1
Remote Control:	Coaxitron, data on coax cable
Video Outputs:	1 Ch Composite BNC, 1 Test monitor 2-pin connector
Accessories included:	Multi-Language Manual, Template, Cable for Service Monitor, Screws, screw driver for Zoom and Focus adjustment
Protection Rating:	IP66
Humidity:	less than 90%, non condensing
Operating Temperature:	-25°C ~ +55°C
Supply Voltage:	12 VDC / 24 VAC
Power Consumption:	8.4 (LED on) W
Weight:	1 kg
Dimensions (WxHxD):	Ø 99 x 224 mm



GCA-B2326T

1/3" CCD Bullet Camera 2.8~12mm 42 IR LED 700L
ext. adj.

- Smart IR LED Control with adjustable level
- Varifocal Lens: f = 2.8 - 12 mm, auto iris, external adjustment
- Concealed Cable Management
- Remote Control Interfaces over Coax (Coaxitron)
- Built-in Service Monitor Port & OSD Control Port
- Video Enhancement: BLC, HLC, DNR, DIS
- 15 polygonal Privacy Zone Masking
- Extended Temperature range -25°C ~ +55°C
- Support Dual Power AC24V/DC12V



DIMENSIONS (MM)

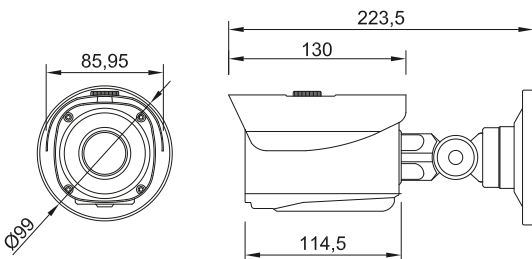

ACCESSORIES

GBR-FB03



GBR-PM02



GKB-A0040P



SPECIFICATIONS

Image Sensor:	1/3" CCD Sony 960H Ex-view HAD II
Scanning System:	PAL, 50Hz, 625L (V), 2:1 Inter Line Transfer
Pixels - Effective:	976(H) x 582(V)
Resolution:	650 (H) lines colour, 700 (H) lines b&w
Co/B&W:	Auto, Color, Removable IR-Cut Filter (ICR)
Sensitivity Colour:	0.7 lux 50IRE @ F1.4 (SensUp=0,AGC off), 0,00001 lux 15IRE @ F1.4(SensUp=x512)
Sensitivity B&W:	0 Lux LED IR on
S/N Ratio:	>52 dB
Lens Focal Length:	2.8 - 12 mm
Viewing Angle:	97° ~ 24°
Lens Drive Type:	Auto iris (DC)
Iris F-Number:	F= 1.4 ~ 360
Adjustment zoom and focus:	External
Sens Up:	Off ~ x512, auto
Motion Detection:	On/ Off/ Sensitivity/ Area setting
Number of Privacy Zones:	15
High Speed Shutter:	1/50 - 1/10.000 sec, auto
BLC: Back Light:	On/Off/HLC
WDR/ATR-EX:	On/Off
Digital Noise Reduction (DNR):	Low/Midlow/Mid/Midhigh/High/Off (2D/3D)
Digital Image Stabilization (DIS):	Off/On
Digital Zoom:	Off/1 ~ 16x
Reverse:	Off/ H-REV/ V-REV/ HV-REV
OSD:	Yes (DE,EN,FR,IT,RU,TR)
Camera ID:	52 character over 2 lines
White Balance:	ATW/Push/User1/User2/AntiCR/Manual/Push Lock
IR LED:	42 pcs.
Optical Wavelength:	850 nm
Max. IR Distance:	30/45 m (according to scene reflexion)
Protection Rating:	IP66
Remote Control:	Coaxitron, data on coax cable
Video Outputs:	1 CVBS 1 Vpp (BNC) & 1 test monitor out
Accessories included:	Multi-Language Manual, Template, Cable for Service Monitor, Screws, screw driver for Zoom and Focus adjustment
Humidity:	less than 95%, non condensing
Operating Temperature:	-25°C ~ +55°C
Supply Voltage:	12 VDC / 24 VAC
Power Consumption:	7.8 (LED on) W
Weight:	1 kg
Dimensions (WxHxD):	99 x 223.5 mm



GCA-B3326T

1/3" CCD Bullet Camera 5~50mm ICR 42 IR LED 700L ext. adj.

- Smart IR LED Control with adjustable level
- Varifocal Lens: $f = 5 - 50$ mm, auto iris, external adjustment
- Concealed Cable Management
- Intelligent Video Content Analysis with Motion Tracking
- Remote Control Interfaces over Coax (Coaxitron)
- Built-in Service Monitor Port & OSD Control Port
- Video Enhancement: BLC, HLC, DNR, DIS
- 15 polygonal Privacy Zone Masking
- Extended Temperature range $-25^{\circ}\text{C} \sim +55^{\circ}\text{C}$
- Support Dual Power AC24V/DC12V



DIMENSIONS (MM)

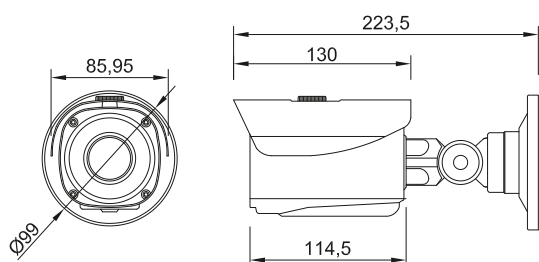

ACCESSORIES

GBR-FB03



GBR-PM02



GKB-A0040P



SPECIFICATIONS

Image Sensor:	1/3" CCD Sony 960H Ex-view HAD II
Scanning System:	PAL, 50Hz, 625L (V), 2:1 Inter Line Transfer
Pixels - Effective:	976(H) x 582(V)
Resolution:	650 (H) lines colour, 700 (H) lines b&w
Co/B&W:	On/Off/Auto/Ext, IR-cut filter removable (ICR)
Sensitivity Colour:	0.8 lux(50IRE)@F1.4(SensUp=0, AGC Off), 0.00001 lux 15IRE (SensUp x512) F1.4
Sensitivity B&W:	0 Lux LED IR on
S/N Ratio:	>52 dB
Lens Focal Length:	5 ~ 50 mm
Viewing Angle:	51° ~ 6.5°
Lens Drive Type:	Auto iris (DC)
Iris F-Number:	F= 1.4 ~ 360
Sens Up:	Off ~ x512, auto
Motion Detection:	On/ Off/ Sensitivity/ Area setting
Number of Privacy Zones:	15
High Speed Shutter:	1/50 ~ 1/10.000 sec, auto
BLC: Back Light:	On/Off/HLC
WDR/ATR-EX:	On/Off
Digital Noise Reduction (DNR):	On/Off (1~6 level)
Digital Image Stabilization (DIS):	Off/On
Digital Zoom:	Off/1 ~ 16x
Reverse:	Off/ H-REV/ V-REV/ HV-REV
OSD:	Yes (DE,EN,FR,RU)
Camera ID:	52 character over 2 lines
White Balance:	ATW/Push/User1/User2/AntiCR/Manual/ Push Lock
Adjustment zoom and focus:	External
IR LED:	42 pcs.
Optical Wavelength:	850 nm
Max. IR Distance:	45/70 m (according to scene reflexion)
Remote Control:	Coaxitron, data on coax cable
Video Outputs:	1 CVBS 1 Vpp (BNC) & 1 test monitor out
Accessories included:	Multi-Language Manual, Template, Cable for Service Monitor, Screws, screw driver for Zoom and Focus adjustment
Protection Rating:	IP66
Humidity:	less than 95%, non condensing
Operating Temperature:	$-25^{\circ}\text{C} \sim +55^{\circ}\text{C}$
Supply Voltage:	12 VDC / 24 VAC
Power Consumption:	7.8 (LED on) W
Weight:	1 kg
Dimensions (WxHxD):	99 x 223.5 mm



GCA-B2357T

1/3" CCD Bullet Camera 3,8~38mm A.FocusZoom lens
ICR 35IR LED xWDR 700L

- Motorized Auto Focus Zoom lens 3,8 ~ 38 mm
- 0 Lux: Integrated LED IR Illuminator to see even in total darkness
- Remote Control Interfaces: Coax
- F-DNR Fog Digital Noise Reduction
- Concealed Cable Management
- Built-in Service Monitor Port & OSD Control Port
- Extended Temperature range -25°C ~ +55°C
- Support Dual Power AC24V/DC12V



DIMENSIONS (MM)

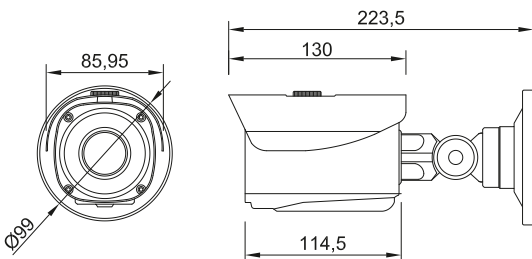

ACCESSORIES

GBR-FB03



GBR-PM02



GKB-A0040P



SPECIFICATIONS

Image Sensor:	1/4" CCD Sony 960H Ex-view HAD II
Scanning System:	PAL, 50Hz, 625L (V), 2:1 Inter Line Transfer
Pixels - Effective:	976(H) x 582(V)
Resolution:	650 (H) lines colour, 700 (H) lines b&w
Col/B&W:	Auto, Color, Removable IR-Cut Filter (ICR)
Sensitivity Colour:	0.9 lux(50IRE)@F1.8 (SensUp=0, AGC Off), 0.00001 lux 15IRE (SensUpx256) F1.8
Sensitivity B&W:	0 Lux LED IR on
Shutter Speed:	AUTO, OFF, FLK, 1/250, 1/500, 1/1000, 1/2000, 1/5000, 1/10000, 1/20000, 1/50000, 1/100000
S/N Ratio:	>52 dB
Lens Focal Length:	3.8 ~ 38 mm
Viewing Angle:	50°(W) ~ 5.5°(T)
Zoom Ratio:	x 10
Lens Drive Type:	Auto iris (DC)
Iris F-Number:	F= 1.8 ~ 360
IR LED:	35 pcs.
Optical Wavelength:	850 nm
Max. IR Distance:	30/45 m (according to scene reflexion)
Digital Zoom:	Off/1 ~ 12x
Sens Up:	Off ~ x256, auto
Motion Detection:	On/ Off/ Sensitivity/ 4 Area setting
Number of Privacy Zones:	8
BLC: Back Light:	BLC, HSBL, OFF, d-WDR
Digital Noise Reduction (DNR):	OFF/ON/SMART (level 0~255)
Reverse:	Off/ H-REV/ V-REV/ HV-REV
OSD:	Yes
Camera ID:	20 character
White Balance:	ATW, AWB, AWC-SET, MANUAL, INDOOR, OUTDOOR
Presettings:	CUSTOM, SPEED DOME, IR MODE, INDOOR, OUTDOOR, LOW LIGHT, HALL WAY
Protection Rating:	IP66
Video Outputs:	1 CVBS 1 Vpp (BNC) & 1 test monitor out
Additional Features:	Image: Freeze, Negative
Accessories included:	Multi-Language Manual, Template, Cable for Service Monitor, Screws
Humidity:	less than 90%, non condensing
Operating Temperature:	-25°C ~ +55°C
Supply Voltage:	12 VDC / 24 VAC
Power Consumption:	7.8 (LED on) W
Weight:	1 kg
Dimensions (WxHxD):	99 x 223.5 mm



GCA-C0335P

Indoor Motorized Dome Camera 12x Zoom ICR WDR

- 12x motorized optical zoom with 12x digital zoom
- 650 TV Lines
- High Speed Pan/Tilt (400°/sec), minimum speed (0.5°/sec)
- WDR function, Colour/B&W function with removable IR cut filter
- Digital Image Stabilization
- 650 TV Lines
- RS485 - Multiprotocol
- Digital Noise Reduction
- For indoor use



DIMENSIONS (MM)

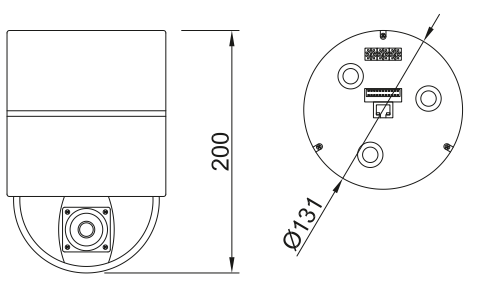

ACCESSORIES

GBR-IC01



GBR-AM01



GBR-WA02



GBR-CM01



GBR-PM01



GBR-CE01



GBR-AM02



SPECIFICATIONS

Image Sensor:	1/4" CCD (Super HAD II)
Pixels - Total:	976x582 (570k)
Resolution:	650 (H) lines
Sensitivity:	0.1 lux (Colour) / 0.01 lux (B&W)
Shutter Speed:	1 ~ 1/10.000 sec
Col/B&W:	On/Off/Auto, IR-cut filter removable (ICR)
Zoom Ratio:	x 12
Focal Length:	3.8 ~ 45.6 mm
Iris Operation:	Auto, Manual
Lens Drive Type:	Auto iris (DC)
Aperture Ratio:	F 1.6 ~ C
Auto Flip:	Image/Mechanic/Off
OSD:	Yes (EN,DE,FR,ES,IT,PT)
Camera ID:	20 character
Digital Image Stabilization (DIS):	Off/On
WDR:	On/Off
BLC: Back Light:	On/Off
White Balance:	Auto, Manual, Indoor, Outdoor
Digital Noise Reduction (DNR):	2DNR/3DNR (Off/On)
AGC:	Auto, Manual
Number of Privacy Zones:	16
Digital Zoom:	Off/1 ~ 12x
Number of Preset:	256
Sequence:	8
Cruise:	8
Autopan:	4
Home position:	Preset/Sequence/Auto Pan/Cruise
Pan Speed:	Manual: 1°/s ~ 80°/s, Preset: 400°/s (max.)
Tilt Speed:	Manual: 0.5°/s ~ 90°/s, Preset: 400°/s (max.)
Range Panning:	360° endless
Range Tilting:	-10° ~ 190°
Preset Accuracy:	0.225°
Alarm Inputs:	8
Alarm Outputs:	1
Alarm functions:	Preset/Sequence/Auto Pan/Cruise
Serial Interface(s):	RS-485/422
Protocol:	Pelco P, Pelco D, AD422, Philips, Kalatel, VCL, JVC, DSCP
Operating Temperature:	0°C ~ +40°C
Humidity:	less than 90%, non condensing
Supply Voltage:	24 VAC/VDC ±10%
Standards:	CE, FCC, RoHS Compliant
Power Consumption:	18 W
Weight:	1.2 kg
Dimensions (WxHxD):	Ø131 x 200 mm



GCA-C0245P

Outdoor Motorized Dome Camera 36x Zoom ICR WDR

- 36x motorized optical zoom with 12x digital zoom
- High Speed Pan/Tilt (400°/sec), minimum speed (0.5°/sec)
- Digital Image Stabilization
- WDR function, Colour/B&W function with removable IR cut filter
- 650 TV Lines
- Digital Noise Reduction
- RS485 - Multiprotocol
- For indoor and outdoor use



DIMENSIONS (MM)

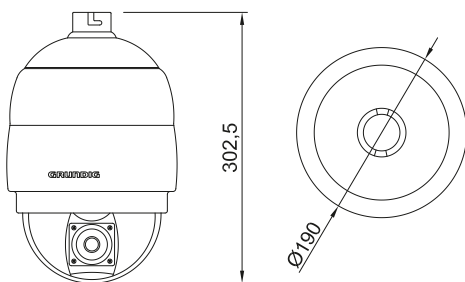

SPECIFICATIONS

Image Sensor:	1/4" CCD (Super HAD II)
Pixels - Total:	976x582 (570k)
Resolution:	650 (H) lines
Col/B&W:	On/Off/Auto, IR-cut filter removable (ICR)
Sensitivity:	0.01 lux @ F1.6 (Colour) / 0.001 lux @ F1.6 (B&W)
Zoom Ratio:	x 36
Focal Length:	3.4 ~ 122.4 mm
Field of View:	52,8° ~ 4,59°
Aperture Ratio:	F 1.6 - C
Lens Drive Type:	Auto iris (DC)
OSD:	Yes, multi language
Camera ID:	20 character
Digital Zoom:	Off/1 ~ 12x
BLC: Back Light:	On/Off
WDR:	On/Off
Digital Noise Reduction (DNR):	2DNR/3DNR (Off/On)
Digital Image Stabilization (DIS):	Off/On
White Balance:	Auto / Manual
Number of Privacy Zones:	16
Presets:	256
Preset Accuracy:	0.225°
Sequence:	8
Cruise:	8
Range Panning:	360° endless
Range Tilting:	-10° ~ 190°
Pan Speed:	Manual: 0.5°/s ~ 90°/s, Preset: 400°/s (max.)
Tilt Speed:	Manual: 0.5°/s ~ 90°/s, Preset: 400°/s (max.)
Alarm Inputs:	8
Alarm Outputs:	1
Protocol:	Pelco P/D, AD422, PHILIPS, Kalatel, VCL, JVC, DSCP
Protection Rating:	IP66 / IK10
Operating Temperature:	-40°C ~ +50°C
Humidity:	less than 90%, non condensing
Supply Voltage:	24 VAC/VDC ±10%
Standards:	CE, FCC, RoHS Compliant
Power Consumption:	65 (w/heater) W
Weight:	2.6 kg
Dimensions (WxHxD):	ø190 x 302.5 mm

ACCESSORIES

GBR-WA02



GBR-CM01



GBR-PM01



GBR-CE01



GBR-AM02



GAC-B0502A





ANALOGUE RECORDERS

GRUNDIG ANALOGUE DIGITAL VIDEO RECORDERS OFFER THE PERFECT CHOICE FOR YOUR VIDEO SURVEILLANCE SYSTEM. BASED ON EMBEDDED LINUX OPERATING SYSTEM THEY ARE STABLE AS A ROCK AND SECURE FROM NETWORK ATTACKS.

THE USER INTERFACE OFFERS A VERY INTUITIVE INSTALLATION AND IS VERY EASY TO USE FOR THE ENDUSER.

CHOOSE THE PERFECT SIZE FOR YOUR SYSTEM STARTING FROM 4 CHANNEL DVR WITH MAX. 4TB OF STORAGE CAPACITY UP TO 16 CHANNEL DVR WITH UP TO 40TB STORAGE CAPACITY.





OVERVIEW STANDALONE DVR

ANALOGUE RECORDERS

MODEL	PICTURE	CHAN- NELS	RECORDING RESOLUTION	RECORDING SPEED	SATA	eSATA	USB	VIDEO OUT	AUDIO IN	ALARM IN	ALARM OUT	PAGE
GRA-D1104B		4	960H (976 × 582), 4CIF (704x576), 2CIF (704x288), CIF (352x288)	100fps (976x582), 100fps (704x576), 100fps (704x288), 100fps (352x288)	1	-	2	1x HDMI, 1x VGA	4 CH	4 x N/O or N/C	1 Relay	95
GRA-D2208B		8	960H (976 × 582), 4CIF (704x576), 2CIF (704x288), CIF (352x288)	200fps (976x582), 200fps (704x576), 200fps (704x288), 200fps (352x288)	2	-	2	1x HDMI, 1x VGA	4 CH	4 x N/O or N/C	1 Relay	96
GRA-D4416B		16	960H (976 × 582), 4CIF (704x576), 2CIF (704x288), CIF (352x288)	400fps (976x582), 400fps (704x576), 400fps (704x288), 400fps (352x288)	2	-	2	1x HDMI, 1x VGA	4 CH	4 x N/O or N/C	1 Relay	97
GRA-D2208A		8	960H (976 × 582), 4CIF (704x576), 2CIF (704x288), CIF (352x288)	200fps (976x582), 200fps (704x576), 200fps (704x288), 200fps (352x288)	5	1	3	1x HDMI, 1x VGA, 3x BNC	8 CH	9 x N/O or N/C, 1x Reset	8 Relay	98
GRA-D4416A		16	960H (976 × 582), 4CIF (704x576), 2CIF (704x288), CIF (352x288)	400fps (976x582), 400fps (704x576), 400fps (704x288), 400fps (352x288)	5	1	3	1x HDMI, 1x VGA, 5x BNC	16 CH	17 x N/O or N/C, 1x Reset	16 Relay	99



GRA-D1104B

4-Ch Standalone DVR 960H H.264

- 4 Channel video 960H Real Time recording capability
- Spot Monitor with 4-Split View and editable Sequence Function
- USB, Remote & FTP Backup function
- Remote monitoring and control through network (LAN)
- Easy to use user interface
- Compatible to French law of August 2007 for quality in CCTV applications



DIMENSIONS (MM)

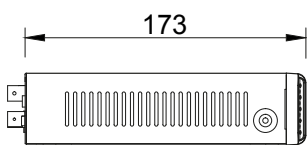
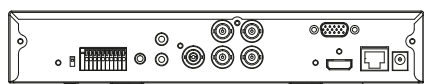
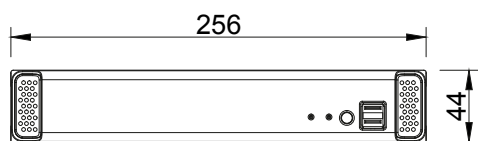

SPECIFICATIONS

Operating System:	Embedded Linux
Video Inputs:	4 CH Composite, BNC
Video Outputs:	1 CVBS BNC (Spot), 1 HDMI, 1 VGA
Max. Storage Capacity:	4 TB SATA
Harddisk bay:	1 x SATA II
Video Compression:	H.264
Recording Resolution:	960H (960x576), 4CIF (704x576), 2CIF (704 x 288), CIF (352x288)
Recording Speed:	100fps (352x288), 100fps (704x288), 100fps (704x576), 100fps (960x576)
Recording Mode:	Continuous, Event Alarm, Motion, Video Loss, Schedule, Manual
Pre-Alarm:	Off, 1, 2, 3, 4, 5, 10, 15 sec.
Post-Alarm:	Off, 1, 2, 3, 4, 5, 10, 15, 30, sec., 1, 2, 3 min.
Display Resolution:	max. 1920 x 1080
Display Speed:	100 fps
Display Mode:	Full screen, 4
Auto Switching:	0, 3, 5, 10, 20, 30 sec, Event or manual, Multi Channel Views
External Backup:	USB HDD, USB Memory, Network, FTP
Watermark:	Yes
Privacy zones:	4 per camera
Search Mode:	Date/Time, Event, Thumbnail
Motion Detection:	On/ Off/ Sensitivity/ Area setting
Event Source:	Motion, Alarm, Text, Video Loss, System
Event Action:	Pop-Up, Relay, E-Mail, Buzzer, PTZ Preset
Audio Inputs:	4 CH, 3.5mm Jack socket
Audio Outputs:	1 CH, 3.5mm Jack socket
Alarm Inputs:	4 contact input N/O or N/C
Alarm Outputs:	1 Relay
Network:	1x 10/100Mbps RJ-45
Serial Interface(s):	2 x USB2, 1 x RS485
Multiplex Function:	Triplex
Video Streaming:	Versatile Dual Streaming
Time Setting:	Setting by NTP Server local or internet
Client software:	Windows (XP, Vista, 7, 8), Web Viewer: IE, Firefox, Safari, Chrome; Mobile: iPhone, Android
Operating Temperature:	0°C ~ +40°C
Humidity:	less than 90%, non condensing
Standards:	CE
Supply Voltage:	12 VDC (External Power Supply)
Power Consumption:	12 W
Weight:	0.9 kg
Dimensions (WxHxD):	250 x 44 x 175 mm



GRA-D2208B

8-Ch Standalone DVR 960H H.264

- 8 Channel video 960H Real-Time recording capability
- Spot Monitor with 4-Split View and editable Sequence Function
- USB, Remote & FTP Backup function
- Remote monitoring and control through network (LAN)
- Easy to use user interface
- Compatible to French law of August 2007 for quality in CCTV applications

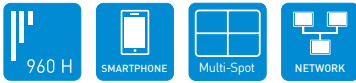

DIMENSIONS (MM)

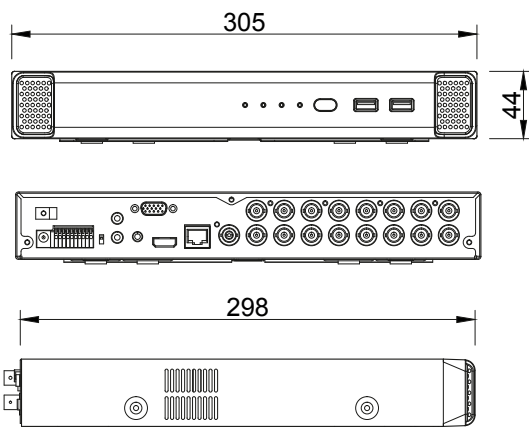

SPECIFICATIONS

Operating System:	Embedded Linux
Video Inputs:	8 CH Composite, BNC
Video Outputs:	1 CVBS BNC (Spot), 1 HDMI, 1 VGA
Max. Storage Capacity:	8 TB (2x4 TB SATA)
Harddisk bay:	2 x SATA II
Video Compression:	H.264
Recording Resolution:	960H (960x576), 4CIF (704x576), 2CIF (704 x 288), CIF (352x288)
Recording Speed:	200fps (352x288), 200fps (704x288), 200fps (704x576), 200fps (960x576)
Recording Mode:	Continuous, Event Alarm, Motion, Video Loss, Schedule, Manual
Pre-Alarm:	Off, 1, 2, 3, 4, 5, 10, 15 sec.
Post-Alarm:	Off, 1, 2, 3, 4, 5, 10, 15, 30, sec., 1, 2, 3 min.
Display Resolution:	max. 1920 x 1080
Display Speed:	200 fps
Display Mode:	Full screen, 4, 6, 8
PTZ Control:	Pan / Tilt / Zoom / Focus / Preset / Sequence / Auto Pan
Auto Switching:	0, 3, 5, 10, 20, 30 sec, Event or manual, Multi Channel Views
External Backup:	USB HDD, USB Memory, Network, FTP
Watermark:	Yes
Privacy zones:	4 per camera
Search Mode:	Date/Time, Event, Thumbnail
Motion Detection:	On/ Off/ Sensitivity/ Area setting
Event Source:	Motion, Alarm, Video Loss, System
Event Action:	Pop-Up, Relay, E-Mail, Buzzer, PTZ Preset
Audio Inputs:	4 CH, 3.5mm Jack socket
Audio Outputs:	1 CH, 3.5mm Jack socket
Alarm Inputs:	4 contact input N/O or N/C
Alarm Outputs:	1 Relay
Network:	1x 10/100/1000Mbps RJ-45
Serial Interface(s):	2 x USB2, 1 x RS485
Multiplex Function:	Triplex
Video Streaming:	Versatile Dual Streaming
Time Setting:	Setting by NTP Server local or Internet
Client software:	Windows (XP, Vista, 7,8), Web Viewer: IE, Firefox, Safari, Chrome; Mobile: iPhone, Android
Operating Temperature:	0°C ~ +40°C
Humidity:	less than 90%, non condensing
Standards:	CE
Supply Voltage:	12 VDC (External Power Supply)
Power Consumption:	35 W
Weight:	1.9 kg
Dimensions (WxHxD):	305 x 44 x 298 mm



GRA-D4416B

16-Ch Standalone DVR 960H H.264

- 16 Channel video 960H Real-Time recording capability
- Spot Monitor with 4-Split View and editable Sequence Function
- USB, Remote & FTP Backup function
- 1 self-adaptive 10/100/1000Mbps Ethernet interface
- USB, Remote & FTP Backup function
- Remote monitoring and control through network (LAN)
- Easy to use user interface
- Compatible to French law of August 2007 for quality in CCTV applications



DIMENSIONS (MM)

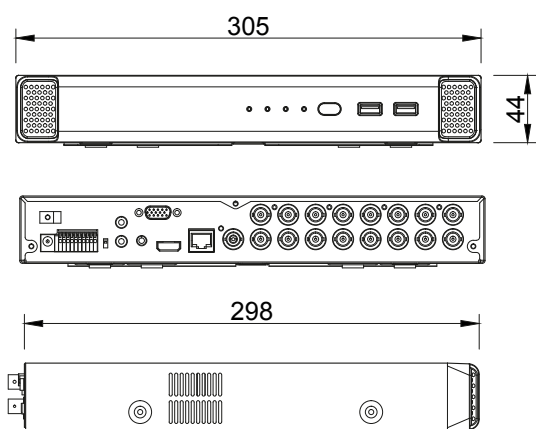

SPECIFICATIONS

Operating System:	Embedded Linux
Video Inputs:	16 CH Composite, BNC
Video Outputs:	1 CVBS BNC (Spot), 1 HDMI, 1 VGA
Max. Storage Capacity:	8 TB (2x4 TB SATA)
Harddisk bay:	2 x SATA II
Video Compression:	H.264
Recording Resolution:	960H (960x576), 4CIF (704x576), 2CIF (704 x 288), CIF (352x288)
Recording Speed:	400fps (352x288), 400fps (704x288), 400fps (704x576), 400fps (960x576)
Recording Mode:	Continuous, Event Alarm, Motion, Video Loss, Schedule, Manual
Pre-Alarm:	Off, 1, 2, 3, 4, 5, 10, 15 sec.
Post-Alarm:	Off, 1, 2, 3, 4, 5, 10, 15, 30, sec., 1, 2, 3 min.
Display Resolution:	max. 1920 x 1080
Display Speed:	400 fps
Display Mode:	Full screen, 4, 6, 8, 9, 16
PTZ Control:	Pan / Tilt / Zoom / Focus / Preset / Sequence / Auto Pan
Auto Switching:	0, 3, 5, 10, 20, 30 sec, Event or manual, Multi Channel Views
External Backup:	USB HDD, USB Memory, Network, FTP
Watermark:	Yes
Privacy zones:	4 per camera
Search Mode:	Date/Time, Event, Thumbnail
Motion Detection:	On/ Off/ Sensitivity/ Area setting
Event Source:	Motion, Alarm, Video Loss, System
Event Action:	Pop-Up, Relay, E-Mail, Buzzer, PTZ Preset
Audio Inputs:	4 CH, 3.5mm Jack socket
Audio Outputs:	1 CH, 3.5mm Jack socket
Alarm Inputs:	4 contact input N/O or N/C
Alarm Outputs:	1 Relay
Network:	1x 10/100/1000Mbps RJ-45
Serial Interface(s):	2 x USB2, 1 x RS485
Multiplex Function:	Triplex
Video Streaming:	Versatile Dual Streaming
Time Setting:	Setting by NTP Server local or internet
Client software:	Windows [XP, Vista, 7, 8], Web Viewer: IE, Firefox, Safari, Chrome; Mobile: iPhone, Android
Operating Temperature:	0°C ~ +40°C
Humidity:	less than 90%, non condensing
Standards:	CE
Supply Voltage:	12 VDC (External Power Supply)
Power Consumption:	37 W
Weight:	1.9 kg
Dimensions (WxHxD):	305 x 44 x 298 mm



GRA-D2208A

8-Ch Standalone DVR 960H H.264

- 8 Channel video 960H Real-Time recording capability
- Aux Monitor with 16-Split View & 2 Spot Monitors with 4-Split View and editable Sequence Function
- Tampering Alarm
- Coaxitron support for telemetry and camera setup
- Free DDNS service
- Multiplex (Live/Playback, Recording, Backup, Networking)
- USB, Remote & FTP Backup function
- Easy to use user interface
- Compatible to French law of August 2007 for quality in CCTV applications
- 19" mountable and rack adapters included



DIMENSIONS (MM)

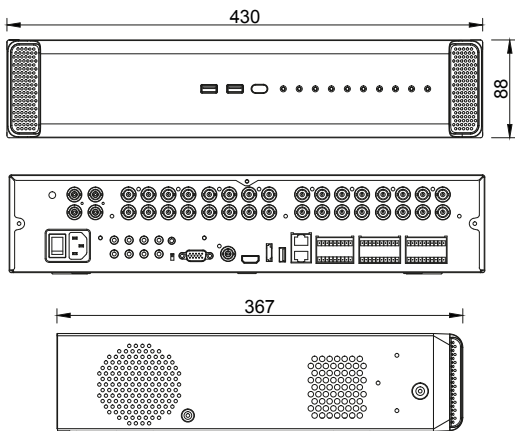

SPECIFICATIONS

Operating System:	Embedded Linux
Video Inputs:	8 CH Composite, BNC, Looped
Video Outputs:	3 CVBS BNC (1 Main, 2 Spots), 1 HDMI, 1 VGA
Harddisk bay:	5 x SATA II
Max. Storage Capacity:	40 TB (5x4 TB SATA and 5x4 TB eSATA)
Video Compression:	H.264
Recording Resolution:	960H (960x576), 4CIF (704x576), 2CIF (704 x 288), CIF (352x288)
Recording Speed:	200fps (352x288), 200fps (704x288), 200fps (704x576), 200fps (960x576)
Recording Mode:	Continuous, Event Alarm, Motion, Video Loss, Schedule, Manual
Pre-Alarm:	Off, 1, 2, 3, 4, 5, 10, 15 sec.
Post-Alarm:	Off, 1, 2, 3, 4, 5, 10, 15, 30, sec., 1, 2, 3 min.
Display Resolution:	max. 1920 x 1080
Display Speed:	200 fps
Display Mode:	Full screen, 4, 6, 8, 9
PTZ Control:	Pan / Tilt / Zoom / Focus / Preset / Sequence / Auto Pan
Auto Switching:	0, 3, 5, 10, 20, 30 sec, Event or manual, Multi Channel Views
External Backup:	USB HDD, USB Memory, Network, FTP
Watermark:	Yes
Privacy zones:	4 per camera
Search Mode:	Date/Time, Event, Thumbnail
Motion Detection:	On/ Off/ Sensitivity/ Area setting
Event Source:	Motion, Alarm, Video Loss, System, Tampering
Event Action:	Pop-Up, Relay, E-Mail, Buzzer, PTZ Preset
Audio Inputs:	8 CH, 3.5mm Jack socket
Audio Outputs:	4 CH, 3.5mm Jack socket
Alarm Inputs:	9 contact input N/O or N/C, 1 contact input for reset
Alarm Outputs:	8 Relay
Network:	2x 10/100/1000Mbps RJ45 ports
Serial Interface(s):	1x RS232, 1x RS485, 3x USB, 1x eSATA
Multiplex Function:	Triplex
Video Streaming:	Versatile Dual Streaming
Time Setting:	Setting by NTP Server local or internet
Client software:	Windows (XP, Vista, 7, 8), Web Viewer: IE, Firefox, Safari, Chrome; Mobile: iPhone, Android
Operating Temperature:	0°C ~ +40°C
Humidity:	less than 90%, non condensing
Standards:	CE
Supply Voltage:	110 ~ 240 VAC/50Hz
Power Consumption:	21 W (without HDD)
Weight:	5.2 kg
Dimensions (WxHxD):	430 x 88 x 367 mm



GRA-D4416A

16-Ch Standalone DVR 960H H.264

- 16 Channel video 960H Real-Time recording capability
- Aux Monitor with 16-Split View & 4 Spot Monitors with 4-Split view and editable Sequence Function
- High Picture Quality: H.264, Full D1(704x576)
- Tampering Alarm
- Coaxitron support for telemetry and camera setup
- Free DDNS service
- Multiplex (Live/Playback, Recording, Backup, Networking)
- USB, Remote & FTP Backup function
- Remote monitoring and control through network (LAN)
- Easy to use user interface
- Compatible to French law of August 2007 for quality in CCTV applications
- 19" mountable and rack adapters included



DIMENSIONS (MM)

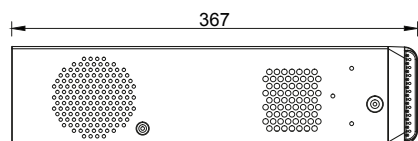
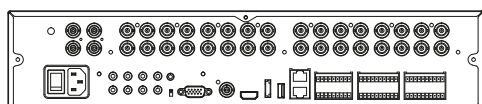
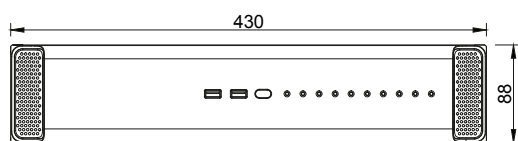

SPECIFICATIONS

Operating System:	Embedded Linux
Video Inputs:	16 CH Composite, BNC, Looped
Video Outputs:	5 CVBS BNC (1 Main, 4 Spots), 1 HDMI, 1 VGA
Harddisk bay:	5 x SATA II
Max. Storage Capacity:	40 TB (5x4 TB SATA and 5x4 TB eSATA)
Video Compression:	H.264
Recording Resolution:	960H (960x576), 4CIF (704x576), 2CIF (704 x 288), CIF (352x288)
Recording Speed:	400fps (352x288), 400fps (704x288), 400fps (704x576), 400fps (960x576)
Recording Mode:	Continuous, Event Alarm, Motion, Video Loss, Schedule, Manual
Pre-Alarm:	Off, 1, 2, 3, 4, 5, 10, 15 sec.
Post-Alarm:	Off, 1, 2, 3, 4, 5, 10, 15, 30, sec., 1, 2, 3 min.
Display Resolution:	max. 1920 x 1080
Display Speed:	400 fps
Display Mode:	Full screen, 4, 6, 8, 9, 16
PTZ Control:	Pan / Tilt / Zoom / Focus / Preset / Sequence / Auto Pan
Auto Switching:	0, 3, 5, 10, 20, 30 sec, Event or manual, Multi Channel Views
External Backup:	USB HDD, USB Memory, Network, FTP
Watermark:	Yes
Privacy zones:	4 per camera
Search Mode:	Date/Time, Event, Thumbnail
Motion Detection:	On/ Off/ Sensitivity/ Area setting
Event Source:	Motion, Alarm, Video Loss, System, Tampering
Event Action:	Pop-Up, Relay, E-Mail, Buzzer, PTZ Preset
Audio Inputs:	16 CH, 3.5mm Jack socket
Audio Outputs:	2 CH, 3.5mm Jack socket
Alarm Inputs:	17 contact input N/O or N/C, 1 contact input for reset
Alarm Outputs:	16
Network:	2x 10/100/1000Mbps RJ45 ports
Serial Interface(s):	1x RS232, 1x RS485, 3x USB, 1x eSATA
Multiplex Function:	Triplex
Video Streaming:	Versatile Dual Streaming
Time Setting:	Setting by NTP Server local or internet
Client software:	Windows (XP, Vista, 7, 8), Web Viewer: IE, Firefox, Safari, Chrome; Mobile: iPhone, Android
Operating Temperature:	0°C ~ +40°C
Humidity:	less than 90%, non condensing
Standards:	CE
Supply Voltage:	110 ~ 240 VAC/50Hz
Power Consumption:	24 W (without HDD)
Weight:	5.5 kg
Dimensions (WxHxD):	430 x 88 x 367 mm

MONITORS







THE PROFESSIONAL, FLAT-SCREEN CCTV MONITORS FROM GRUNDIG HAVE BEEN DEVELOPED SPECIFICALLY FOR VIDEO SURVEILLANCE APPLICATIONS. THEY USE LED BACKLIGHT TECHNOLOGY TO PRODUCE HIGH-CONTRAST IMAGES WITH ACCURATE COLOUR RENDITION. THEY ARE DESIGNED FOR 24/7 OPERATION AND HAVE A LOW POWER CONSUMPTION, WHICH KEEPS RUNNING COSTS AND THEIR ENVIRONMENTAL IMPACT TO A MINIMUM.





OVERVIEW MONITORS

MONITORS

MODEL	PICTURE	PANEL SIZE"	RESOL.	VIDEO INPUT	SPEAKER	CON-TRAST RATIO	BRIGHT-NESS	RESP. TIME	TEM-PERED GLASS	METAL CABINET	PIP	POWER
GMT-1031P		10.4"	800(H) x 600(V)	1 CH Composite BNC looped, 1 CH VGA	-	300:1	350 cd/ m ²	8 ms	yes	yes	-	12V DC external
GML-1030MD		2x 9.7"	1024(H) x 768(V)	4 CH Composite, BNC Looped, 2 CH VGA, 2 HDMI	" 3W (2x1.5W built-in) "	1000:1	400 cd/ m ²	4 ms	yes	yes	-	2x 12V DC external
GML-1730M		17"	1280(H) x 1024(V)	2 CH Composite, BNC Looped, 1 HDMI, 1 CH VGA	" 3W (2x1.5W built-in) "	10000:1	300 cd/ m ²	5 ms	yes	-	PIP/PBP	12V DC external
GML-1930M		19"	1280(H) x 1024(V)	2 CH Composite, BNC Looped, 1 HDMI, 1 CH VGA	" 3W (2x1.5W built-in) "	10000:1	300 cd/ m ²	5 ms	yes	-	PIP/PBP	12V DC external
GML-1931M		19"	1280(H) x 1024(V)	2 CH Composite, BNC Looped, 1 HDMI, 1 CH VGA	" 3W (2x1.5W built-in) "	10000:1	300 cd/ m ²	5 ms	yes	yes	PIP/PBP	12V DC external
GML-2231M		21.5"	1920(H) x 1080(V)	1 CH Composite, BNC Looped, 2 HDMI, 1 CH VGA	" 3W (2x1.5W built-in) "	10000:1	300 cd/ m ²	5 ms	no	yes	PIP/PBP	12V DC external
GML-2431M		23.6"	1920(H) x 1080(V)	1 CH Composite, BNC Looped, 2 HDMI, 1 CH VGA	" 3W (2x1.5W built-in) "	10000:1	300 cd/ m ²	5 ms	no	yes	PIP/PBP	12V DC external



GMT-1031P

27 cm (10.4") LCD/TFT Monitor

- Displays a full, flat 10.4" (26cm) diagonal image
- High Contrast Ratio
- Wall bracket included
- 1 CVBS looped, 1 VGA video inputs
- Metal cabinet
- Remote-Control (Infrared) included
- Power supply included
- Wide Viewing Angle
- Tempered glass



SPECIFICATIONS

Pixels - Total:	800(H) x 600(V)
Pixel Pitch:	0.264 mm(H) x 0.264 mm(V)
Resolution:	800 x 600
Aspect Ratio:	04:03
Video Standard:	PAL/NTSC
Video Inputs:	1 CH Composite, BNC, Looped / 1 CH VGA
Viewing Angle:	140°(H) - 110°(V)
Contrast ratio:	300:01
Brightness:	350 cd/m ²
Response Time:	8 ms
Number of Colours:	16.7 million
Display protection:	Tempered Glass
Display Mode:	AV (BNC), VGA
OSD:	Yes, multi language
Operating Temperature:	0°C ~ +50°C
Storage Temperature:	-20°C ~ +60°C
Accessories included:	Table stand bracket & PSU & VGA cable
MTBF at 25° C:	> 30,000 hours
Vesa Mount:	75 x 75 mm
Supply Voltage:	12 VDC, (100~240 VAC, 50/60Hz)
Power Consumption:	8 W
Weight:	1.71 kg
Dimensions (WxHxD):	268 x 214 x 41.5 mm

DIMENSIONS (MM)

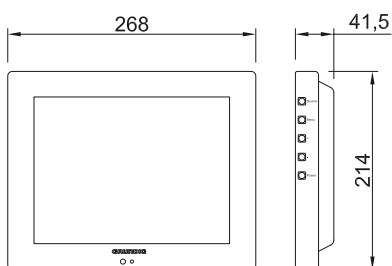



GML-1030MD

24.6 cm (9.7") LCD/TFT

Dual Rackmount Monitor LED Backlight

- Displays two full, flat 9.7" (24.6cm) diagonal image
- High Contrast Ratio
- 2 CVBS looped, 1 VGA video inputs, 1 HDMI for each display
- Metal cabinet
- Tempered glass
- 19" mountable



SPECIFICATIONS

Pixels - Total:	1024(H) x 768(V)
Pixel Pitch:	0.192 mm(H) x 0.192 mm(V)
Resolution:	1024 x 768 @ 60Hz
Aspect Ratio:	04:03
Video Standard:	PAL/NTSC
Video Inputs:	2 CH Composite, BNC Looped, 1 CH VGA, 1 HDMI for each display
Audio Inputs:	3 CH (1xHDMI, 1xCinch [L/R], 1xTRS Connector) for each display
Viewing Angle:	178°(H) - 178°(V)
Contrast ratio:	1000:01
Brightness:	400 cd/m ²
Response Time:	4 ms
Number of Colours:	262K
Display Mode:	AV (BNC), VGA, HDMI
Display protection:	Tempered Glass
OSD:	Yes, multi language
Speaker Output:	1.5 W x2
Operating Temperature:	0°C ~ +40°C
Storage Temperature:	-10°C ~ +60°C
Accessories included:	Power Cord, Power Adapter, User Manual, VGA cable
Vesa Mount:	75/100 mm
Supply Voltage:	12 VDC, (100~240 VAC, 50/60Hz)
Power Consumption:	30 W
Weight:	3.1 kg
Dimensions (WxHxD):	221.4x446x47 mm

DIMENSIONS (MM)

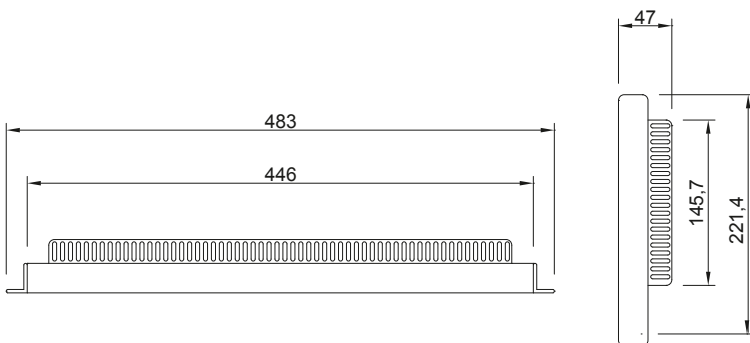

ACCESSORIES

GAM-B0103A
Power Supply Bracket





GML-1730M

43 cm (17") LCD/TFT Monitor with LED Backlight

- Displays a full, flat 17"(43cm) diagonal image
- LED Backpanel illumination
- Energy-saving (green technology)
- 2 CVBS looped, 1 HDMI, VGA video inputs
- Scratch protection glass with anti-reflection coating
- On- screen- menus (Multi-Language)



SPECIFICATIONS

LCD Panel size:	17" Diagonal AM-TFT LED Backlight
Pixels - Total:	1280(H) x 1024(V)
Pixel Pitch:	0.264 mm(H) x 0.264 mm(V)
Resolution:	1280 x 1024 pixel, 650(H) TV Lines
Aspect Ratio:	05:04
Video Standard:	PAL/NTSC
Video Inputs:	2 CH Composite BNC Looped, 1 HDMI; 1 CH VGA
Audio Inputs:	3 CH (1xHDMI, 1xCinch (L/R), 1xTRS Connector)
Brightness:	300 cd/m ²
Contrast ratio:	10.000:1
Number of Colours:	16.7 million
Viewing Angle:	170°(H) ~ 160°(V)
Response Time:	5 ms
Display protection:	Tempered Glass
Speaker Output:	3W (2x1.5W built-in)
PIP:	On/Off
PBP:	On/Off
MTBF at 25° C:	> 100,000 hours
Operating Temperature:	0°C ~ +40°C
Humidity:	10 ~ 90% no condensation
Storage Temperature:	-10°C ~ +60°C
Suitable for:	VESA 75
Supply Voltage:	12 VDC, (100~240 VAC, 50/60Hz)
Power Consumption:	15 W
Weight:	3.4 kg
Dimensions (WxHxD):	385 x 384 x 165 mm

DIMENSIONS (MM)

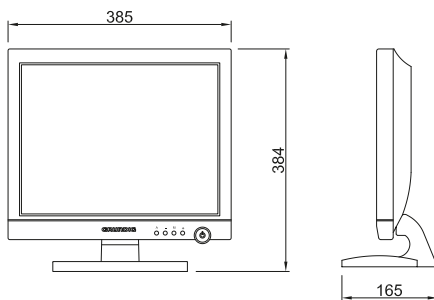

ACCESSORIES

GAM-B0103A
Power Supply Bracket





GML-1930M

48 cm (19") LCD/TFT Monitor with LED Backlight

- Displays a full, flat 19" (48cm) diagonal image
- LED Backpanel illumination
- Energy-saving (green technology)
- 2 CVBS looped, 1 HDMI, VGA video inputs
- Scratch protection glass with anti-reflection coating
- Onscreenmenus (Multi-Language)
- Designed for professional 24/7 usage

SPECIFICATIONS

LCD Panel size:	19" Diagonal AM-TFT LED Backlight
Pixels - Total:	1280(H) x 1024(V)
Pixel Pitch:	0.294 mm(H) x 0.294 mm(V)
Resolution:	1280 x 1024 pixel, 650(H) TV Lines
Aspect Ratio:	05:04
Video Standard:	PAL/NTSC
Video Inputs:	2 CH Composite BNC Looped, 1 HDMI; 1 CH VGA
Audio Inputs:	3 CH (1xHDMI, 1xCinch (L/R), 1xTRS Connector)
Brightness:	300 cd/m ²
Contrast ratio:	10.000:1
Number of Colours:	16.7 million
Viewing Angle:	170°(H) - 160°(V)
Response Time:	5 ms
Display protection:	Tempered Glass
Speaker Output:	3W [2x1.5W built-in]
PIP:	On/Off
PBP:	On/Off
MTBF at 25° C:	> 100,000 hours
Operating Temperature:	0°C ~ +40°C
Humidity:	10 ~ 90% no condensation
Storage Temperature:	-10°C ~ +60°C
Suitable for:	VESA 75
Supply Voltage:	12 VDC, (100-240 VAC, 50/60Hz)
Power Consumption:	15 W
Weight:	3.5 kg
Dimensions (WxHxD):	424 x 415 x 165 mm



DIMENSIONS (MM)

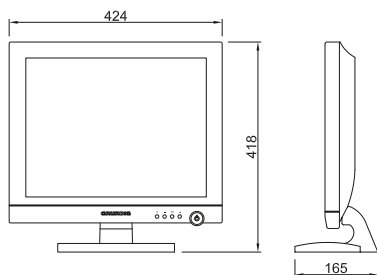

ACCESSORIES

GAM-B0103A
Power Supply Bracket





GML-1931M

48 cm (19") LCD/TFT Monitor LED Backlight Metal Case

- Displays a full, flat 19" (48cm) diagonal image
- LED Backpanel illumination
- Energy-saving (green technology)
- 2 CVBS looped, 1 HDMI, VGA video inputs
- Scratch protection glass with anti-reflection coating
- Metal cabinet
- Designed for professional 24/7 usage



SPECIFICATIONS

LCD Panel size:	19" Diagonal AM-TFT LED Backlight
Pixels - Total:	1280(H) x 1024(V)
Pixel Pitch:	0.294 mm(H) x 0.294 mm(V)
Resolution:	1280 x 1024 pixel, 650(H) TV Lines
Aspect Ratio:	05:04
Video Standard:	PAL/NTSC
Video Inputs:	2 CH Composite BNC Looped, 1 HDMI; 1 CH VGA
Audio Inputs:	3 CH (1xHDMI, 1xCinch (L/R), 1xTRS Connector)
Brightness:	300 cd/m ²
Contrast ratio:	10.000:1
Number of Colours:	16.7 million
Viewing Angle:	170°(H) - 160°(V)
Response Time:	5 ms
Display protection:	Tempered Glass
Speaker Output:	3W (2x1.5W built-in)
PIP:	On/Off
PBP:	On/Off
MTBF at 25° C:	> 100,000 hours
Operating Temperature:	0°C ~ +40°C
Humidity:	10 ~ 90% no condensation
Storage Temperature:	-10°C ~ +60°C
Suitable for:	VESA 100
Supply Voltage:	12 VDC, (100~240 VAC, 50/60Hz)
Power Consumption:	15 W
Weight:	5.41 kg
Dimensions (WxHxD):	415.5 x 367 x 72 mm

DIMENSIONS (MM)

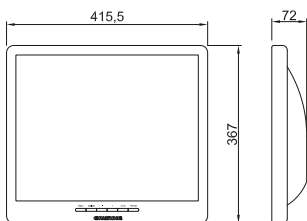

ACCESSORIES

GAM-B0103A

Power Supply Bracket





GML-2231M

54.6 cm (21.5") LCD/TFT Monitor LED Backlight

- Full-HD TFT-LCD monitor
- Displays a full, flat 21,5" (54.6 cm) diagonal image
- LED Backpanel illumination
- Scratch protection glass with anti-reflection coating
- Energy-saving (green technology)
- 1 CVBS looped, 2 HDMI, VGA video inputs



SPECIFICATIONS

LCD Panel size:	21,5" Diagonal AM-TFT LED Backlight
Pixels - Total:	1920(H) x 1080(V)
Pixel Pitch:	0.248 mm(H) x 0.248 mm(V)
Aspect Ratio:	16:09
Video Standard:	PAL/NTSC
Video Inputs:	1 CH Composite BNC Looped, 2 HDMI; 1 CH VGA
Audio Inputs:	4 CH (2xHDMI, 1xCinch (L/R), 1xTRS Connector)
Brightness:	300 cd/m ²
Contrast ratio:	10.000:1
Number of Colours:	16.7 million
Viewing Angle:	160°(H) - 170°(V)
Response Time:	5 ms
Display protection:	Tempered acryl glass with anti-reflection coating
Speaker Output:	3W (2x1.5W built-in)
OSD:	Yes, multi language
PIP:	On/Off
PBP:	On/Off
MTBF at 25° C:	> 100,000 hours
Operating Temperature:	0°C ~ +40°C
Humidity:	10 ~ 90% no condensation
Storage Temperature:	-10°C ~ +60°C
Suitable for:	VESA 100
Supply Voltage:	12 VDC, (100-240 VAC, 50/60Hz)
Power Consumption:	25 W
Weight:	3.6 kg
Dimensions (WxHxD):	524 x 375 x 175 mm

DIMENSIONS (MM)

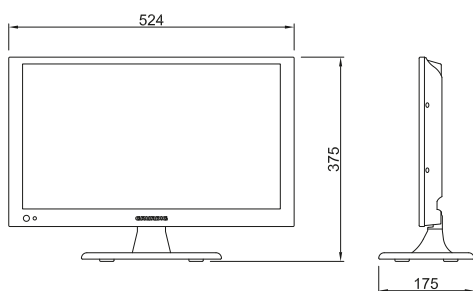

ACCESSORIES

GAM-B0103A
Power Supply Bracket





GML-2431M

61 cm (23.6") LCD/TFT Monitor LED Backlight

- Full-HD TFT-LCD monitor
- Displays a full, flat 23.6" (61 cm) diagonal image
- LED Backpanel illumination
- Scratch protection glass with anti-reflection coating
- Energy-saving (green technology)
- 1 CVBS looped, 2 HDMI, VGA video inputs



SPECIFICATIONS

LCD Panel size:	23,6" Diagonal AM-TFT LED Backlight
Pixels - Total:	1920(H) x 1080(V)
Pixel Pitch:	0.272 mm(H) x 0.272 mm(V)
Aspect Ratio:	16:09
Video Standard:	PAL/NTSC
Video Inputs:	1 CH Composite BNC Looped, 2 HDMI; 1 CH VGA
Audio Inputs:	4 CH (2xHDMI, 1xCinch (L/R), 1xTRS Connector)
Brightness:	300 cd/m ²
Contrast ratio:	10.000:1
Number of Colours:	16.7 million
Viewing Angle:	160°(H) - 160°(V)
Response Time:	5 ms
Display protection:	Tempered acryl glass with anti-reflection coating
Speaker Output:	3W (2x1.5W built-in)
OSD:	Yes, multi language
PIP:	On/Off
PBP:	On/Off
MTBF at 25° C:	> 100,000 hours
Operating Temperature:	0°C ~ +40°C
Humidity:	10 ~ 90% no condensation
Storage Temperature:	-10°C ~ +60°C
Suitable for:	VESA 100
Supply Voltage:	12 VDC, (100~240 VAC, 50/60Hz)
Power Consumption:	30 W
Weight:	4 kg
Dimensions (WxHxD):	580 x 407 x 175 mm

DIMENSIONS (MM)

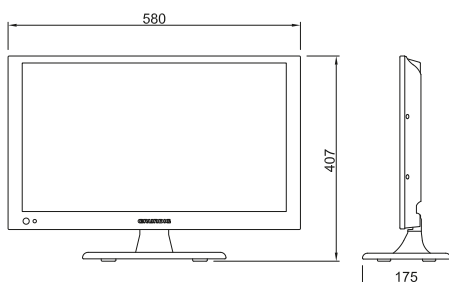

ACCESSORIES

GAM-B0103A

Power Supply Bracket



TRANSMISSION

USE THE GRUNDIG TRANSMISSION PRODUCTS TO BRIDGE LARGE DISTANCES IN YOUR NETWORK. BY SUPPORTING A RANGE OF MEDIA (FIBRE OPTIC CABLE, TELEPHONE WIRE, COAXIAL CABLE) GRUNDIG TRANSMISSION PRODUCTS CAN FLEXIBLY CONNECT TO EXISTING WIRING. THIS GUARANTEES REAL TIME TRANSFER OF VIDEO DATA, USING THE LATEST STANDARDS IN NETWORK TECHNOLOGY.





GEC-D2201AR-1 1-Ch Video/Audio Encoder D1 Quad Stream H.264/MJPEG

- One channel IP digital video server
- Video and audio realtime transmission
- H.264 & MJPEG compression modes (max. 50 fps)
- ONVIF Profile S
- Video resolution: D1, CIF
- Support PTZ protocol: Pelco-P and Pelco-D
- Power input DC12V and PoE
- Web viewer by Internet Explorer or by Software included
- Power output 12VDC 0.58A (7 W)



DIMENSIONS (MM)

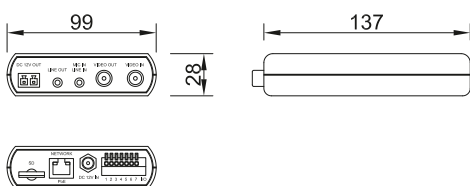

SPECIFICATIONS

Video Inputs:	1 CH Composite, BNC
Video Outputs:	1 x BNC Loop out, 1V _s /750hm
Audio Inputs:	1x 3.5mm jack
Audio Outputs:	1x 3.5mm jack
Power Output:	12 VDC / 580 mA
Network:	10/100Mbps
DDNS:	Supporting Public DDNS servers *
Alarm Input:	On, Off, by Schedule
Time Lapse:	Off, On (60~3600s)
Manual Trigger:	On, Off
Audio detection:	Off, On
Schedule:	Single Day or Week, Time (Start, Duration), DAY or NIGHT Mode
Camera ID:	15 character, 1 lines
Reverse:	Normal, Flip, Mirror, Vertical Mode (90°clockwise,90° counter clockwise), 180°
Privacy zones:	5
Privacy Zone Type:	rectangle, Color selection
Alarm Event:	Enable Alarm Output, Send message by FTP or/and Email, Upload image by FTP or/and Email, Send HTTP notification, Record to Micro SD Card
Video Compression:	H.264 (MPEG-4Part 10/AVC), MJPEG
ONVIF compliant:	Profile S
Video Streaming:	Single Stream, Dual Stream, Triple Stream, Quad stream
Video Resolution:	D1 (720x576), VGA (640x480), CIF (352x288)
Frame Rate (Max@Resolution):	max.: 50fps@D1 720x576, 50fps@VGA 640x480, 50fps@CIF 352x288
Audio Compression:	G.726, G.711, Bi-directional
Alarm Inputs:	1 (5V, 10KΩ)
Alarm Outputs:	1 (max.300VDC/AC, 39W)
PTZ Control:	Pan/Tilt/Zoom/Focus, Camera OSD
Access protection:	By log-in and Password, IP filter, IEEE802.1x
Login Access Level:	up to 20 user, 1 Administrator
Number of Clients:	Up to 20 simultaneously
Micro SDHC memory:	Supports up to 32GB
Recording Types:	on micro SD/SDHC CARD:, Single Image Recording (JPEG), Video(AVI), on NAS: Video(AVI)
Web Browser:	MS Internet Explorer 6.0 (or higher), Firefox, Google Chrome, Safari
Network Protocol:	IPv4/v6, TCP/IP, UDP, RTP, RTSP, HTTP, HTTPS, DHCP, PPPoE, UPnP, SMTP, ICMP, IGMP, SNMP, IEEE802.1x, QoS, ONVIF, FTP, ARP
LED Indicator:	Power, link, active
Input/Output sockets:	Micro Card Slot, RJ45 Network connector, Input Power DC connector, 7 Pin Terminal Block (3Pin RS485, 4 Pin Alarm I/O), 2 x Ø3,5 mm Jack , (Audio I/O), 2Pin Power Output Screw block, 2 x BNC Connectors
Serial Interface(s):	RS-485
Power Connector:	5,5 x 2,1 x 11 mm
Operating Temperature:	-10°C ~ +50°C
Humidity:	10 ~ 90% no condensation
Standards:	CE, FCC, RoHS Compliant
Supply Voltage:	12 ~ 48 VDC, 24 VAC or PoE
Power Consumption:	5 W
Weight:	0.2 kg
Dimensions (WxHxD):	137 x 99 x 28 mm



GTI-F0022C

Ethernet transmission (VDSL2) over coaxial cable (pair)

- 1 full-duplex VDSL links via coaxial cable (up to 200m RG59)
- Selectable CO and CPE mode
- Selectable fast and interleaved mode
- Selectable target SNR margin
- Compliant with ETSI, ITU and ANSI standards
- Metal housing

SPECIFICATIONS

Standard:	IEEE 802.3 10BaseT, IEEE 802.3u 100BaseTX, IEEE 802.3x full Duplex, ETSI, ITU, ANSI, Full ITU-T G993.2 (VDSL2) compatible
Interfaces:	G.997.1 compatible, BNC for coaxial cable, RJ-45 female Ethernet jack
Switching Method:	Store and Forward
LED Indicators:	Duplex, Speed, Link/Act, Power, Master, Link/Negotiation
Supply Voltage:	5 VDC
Operating Temperature:	0°C ~ +45°C
Storage Temperature:	-20°C ~ +90°C
Humidity:	10 ~ 90% no condensation
Regulation:	CE, FCC Class A
Power Consumption:	10 W
Weight:	0.28 kg
Dimensions (WxHxD):	75 x 23 x 102 mm



GTI-F0025N

Ethernet transmission (VDSL2) over telephone cable (pair)

- 1 full-duplex VDSL links via (RJ11) telephone cable (up to 1000m)
- selectable CO and CPE mode
- selectable fast and interleaved mode
- Selectable target SNR margin
- Compliant with ETSI, ITU and ANSI standards
- Metal housing

SPECIFICATIONS

Standard:	IEEE 802.3 10BaseT, IEEE 802.3u 100BaseTX, IEEE 802.3x full Duplex, ETSI, ITU, ANSI, Full ITU-T G993.2 (VDSL2) compatible
Interfaces:	G.997.1 compatible, RJ11 female Phone jack, RJ-45 female Ethernet jack
Switching Method:	Store and Forward
Forwarding Rates:	100Mbps port - 148.800pps, 10Mbps port - 14.880pps
Transmission Media:	10BaseT CAT. 3, 4, 5 UTP/STP, 100BaseTX CAT. 5 UTP/STP
LED Indicators:	Duplex, Speed, Link/Act, Power, Master, Link/Negotiation
Supply Voltage:	5 VDC
Operating Temperature:	0°C ~ +45°C
Storage Temperature:	-20°C ~ +90°C
Humidity:	10 ~ 90% no condensation
Regulation:	CE, FCC Class A
Power Consumption:	4 W
Weight:	0.28 kg
Dimensions (WxHxD):	75 x 23 x 102 mm



GTI-F0811E

PoE Extender IEEE802.af, 2W/100m, cascable

- IEEE 802.af, IEEE 802.3 10BaseT, IEEE 802.3u 100BaseTX
- No extra power required
- 1-port PoE Splitter (PD) and 1-Port PoE injector (PSE)
- need around 2W per extension
- Metal housing

SPECIFICATIONS

Standards:	IEEE 802.3, IEEE 802.3u, IEEE 802.3x
Interfaces:	1 x PD (Data + Power in), 1 x PSE (Data+Power out)
Filtering/Forwarding Rate:	10Mbps port - 14,880 pps, 100Mbps port - 148,800 pps
Transmission Media:	100BaseTX Cat. 5/5e/6 UTP/STP, up to 100m
LED Indicators:	PoE IN: PD (Link), Port 2: PD Link/Act, PoE Out: Link, Port 1: PSE Link/Act
Supply Voltage:	PoE IN/OUT (IEEE 802.3af)
Operating Temperature:	0°C ~ +55°C
Storage Temperature:	-20°C ~ +90°C
Humidity:	10 - 90% no condensation
Regulation:	CE, FCC Class A
Power Consumption:	2 W
Weight:	0.252 kg
Dimensions (WxHxD):	130 x 24 x 77 mm



GAX-P9830A

High Power Gigabit Ethernet Injector IEEE802.at

- 1 x Data input port compliant with IEEE 802.3 10BaseT, IEEE802.3u 100BaseTX and IEEE 802.3ab 1000BaseT
- Extending distance for another 100m per Extender and cascading for longer distances
- 1 x PSE/PoE+ output port compliant with IEEE 802.3af PoE and IEEE802.3at PoE+
- Supporting the power Max. 30 W for PSE/PoE+ port
- Output port has output current limited, short-circuit protection, complete Power Device (PD) detection and classification
- Smart plug & play
- Metal housing

SPECIFICATIONS

Standards:	IEEE 802.af, IEEE 802.at, IEEE 802.3, IEEE 802.3u, IEEE 802.3ab
Interfaces:	1 x RJ45 Data input, 1 x RJ45 Data + Power output
LED Indicators:	Power and PD Link
Supply Voltage:	48 VDC
Power Output:	48 VDC / 30 W
Operating Temperature:	0°C ~ +45°C
Storage Temperature:	-20°C ~ +85°C
Humidity:	10 - 90% no condensation
Regulation:	CE, FCC Class A
Power Consumption:	35 W
Weight:	0.19 kg
Dimensions (WxHxD):	75 x 23 x 102 mm



GTI-F1026F 10/100BaseTX to 100BaseFX Media Converter (ST,MM,2km)

- 1 x 10/100 BaseTX Ethernet TP Port and 1 x 100BaseFX Ethernet Fiber Port
- Fiber Port can support Multimode wire with ST connector
- Full- and Half-Duplex selection on FX Port over a slide switch
- Providing 19" Converter Chassis for up to 16 slots with redundant power supply for optional expansion use
- Metal housing

SPECIFICATIONS

Standards:	IEEE 802.3, IEEE 802.3u
Interfaces:	1 x 10/100BaseT with RJ45 Connector; 1 x 100BaseFX with Multi Mode, ST Fiber connector
Wavelength:	850nm / 1310nm
Transmitter Output Power:	-20 ~ -14 dBm
Receiver Sensitivity:	max. -31 dBm
Power Budget:	11 dBm
Data Transfer Rate:	Ethernet: 10Mbps/Half-Duplex, 20Mbps/Full-Duplex, Fast Ethernet: 100Mbps/Half-Duplex, 200Mbps/Full-Duplex
Transmission Media:	10BaseT Cat. 3, 4, 5 UTP/STP, up to 100m, 100BaseTX Cat. 5 UTP/STP, up to 100m, 100BaseFX: 50/125µm or 62,5/125µm Multi Mode ST-Type Fiber optical cable, up to 2km
LED Indicators:	Per Port: (TX): Link/Act, Speed, FDX/COL, (FX): Link/Act, FDX/COL, Per unit: Power
Supply Voltage:	5 VDC
Operating Temperature:	0°C ~ +60°C
Storage Temperature:	-20°C ~ +90°C
Humidity:	10 ~ 90% no condensation
Regulation:	CE, FCC Class A
Power Consumption:	10 W
Weight:	0.23 kg
Dimensions (WxHxD):	74 x 22 x 102 mm



GTH-C0041C 4 CH CVBS to HD-SDI Converter

- Full HD, 1920 x 1080p Output
- 4 channel split screen on one HD-SDI channel
- Output resolution setup

SPECIFICATIONS

Video Inputs:	4 CH Composite, BNC
Video Outputs:	1 Ch HD-SDI BNC
Video Resolution:	4 CIF (704x576) Input
Video Resolution:	1920 x 1080 (25p/30p/50i/60i/50p/60p) Output
Max. Distance:	up to 150 m (RG6)
LED Indicator:	Power
Compliant:	SMPTE-292/296M
Operating Temperature:	0°C ~ +50°C
Humidity:	less than 80%, non condensing
Supply Voltage:	12 VDC (External Power Supply)
Power Consumption:	6 W
Weight:	0.21 kg
Dimensions (WxHxD):	93x92.5x35 mm



GTH-K0010M 1Ch HD-SDI to HDMI Converter

- HD-SDI to HDMI converter
- Full HD, 1920 x 1080p, 25/30 fps
- SMPTE 292/296M compliant
- Automatic Re-clocking and Equalisation
- Cascade up to 4 devices

SPECIFICATIONS

Video Inputs:	1 CH HD-SDI, BNC
Video Outputs:	1 HDMI
Video Resolution:	1080p 60RB, 1080p 60, 1080i 60, 720p 60
LED Indicator:	Power, link
Compliant:	SMPTE 274M/292M/296M
Operating Temperature:	0°C ~ +50°C
Humidity:	less than 80%, non condensing
Supply Voltage:	12 VDC (External Power Supply)
Power Consumption:	4 W
Weight:	0.14 kg
Dimensions (WxHxD):	115 x 26x 65 mm



GTH-K0011E

1Ch Repeater & 2 Ch Distributor

- HD-SDI 1Ch repeater & 2 Ch Distributor
- Full HD, 1920 x 1080p, 25/30 fps
- Automatic Re-clocking and Equalisation

SPECIFICATIONS

Video Inputs:	1 CH HD-SDI, BNC
Video Outputs:	2 CH HD-SDI, BNC
Video Resolution:	SMPTE 274M (1080i 50/60, 1080p 25/30), SMPTE 296M (720p 25/30/50/60)
Max. Distance:	up to 140m (RG59), up to 200m (RG6)
LED Indicator:	Power, link
Compliant:	SMPTE 274M/292M/296M
Operating Temperature:	0°C - +50°C
Humidity:	less than 80%, non condensing
Supply Voltage:	12 VDC (External Power Supply)
Regulation:	CE, FCC Class A
Power Consumption:	3 W
Weight:	0.12 kg
Dimensions (WxHxD):	92 x 26 x 65 mm

HOUSINGS & BRACKETS

NO MATTER WHERE THE CAMERA IS MOUNTED, GRUNDIG HOUSINGS OFFER A WIDE VARIETY FITTING TO THE ENVIRONMENTAL CONDITIONS AND DESIGN. EASY TO INSTALL, STYLISH AND MADE TO PROTECT THE PRECIOUS GRUNDIG DEVICE EVEN UNDER HARSH CONDITIONS.





GBR-WA03	GBR-WA04	GBR-WB02	GBR-FB03	GBR-PM02
				
Box Camera Wall Mount Bracket	Wall bracket for AV Dome	Wedge Base for AV Dome	Junction Box for Bullet Cameras	Pole Mount Adapter
Camera mount: 1/4" - 20 UNC thread	Suitable for: GCA-B4323V, GCA-B4325V, GCA-B4326V, GCA-B4327V, GCA-B5325V, GCA-B5326V, GCA-C2357V, GCA-H0325V, GCH-K1325V(-1), GCH-K1327V(1-)	Suitable for: GCA-B4323V, GCA-B4325V, GCA-B4326V, GCA-B4327V, GCA-B5325V, GCA-B5326V, GCA-C2357V, GCA-H0325V, GCH-K1325V(-1), GCH-K1327V(1-)	Suitable for: GCA-B2326T, GCA-B3326T, GCA-B2357T, GCA-H0325T, GCH-K0326T, GCH-K1327T(-1)	Suitable for: GBR-WA04, GBR-FB03, GCA-B2326T, GCA-B2357T, GCA-B3326T, GCA-H0325T, GCH-B0326T, GCH-K1327T(-1)
Mounting distance from fixing point: 130 mm (wall), 160 mm (ceiling)	Load max.: 2 kg	Body material: Die cast aluminium	Body material: Die cast aluminium	Body material: Steel
Load max.: 2 kg	Body material: Aluminium	Colour: Shiny white	Colour: Shiny white	Colour: White
Body material: Aluminium	Colour: White	Weight: 0.5 kg	Weight: 0.2 kg	Pole: Ø 90 to 150 mm
Colour: White	Weight: 0.715 kg	Dimensions (WxHxD): Ø 152 X 70 mm	Dimensions (WxHxD): Ø 99 X 45 mm	Weight: 0.3 kg
Weight: 0.2 kg	Dimensions (WxHxD): 144.6 x 110.5 x 268.8 mm			Dimensions (WxHxD): 100 x 110 x 45 mm
Dimensions (WxHxD): Ø 90 x 160 mm				

GBR-CE02	GBR-WA06	GBR-IC06	GBR-IC04	GBR-IC01
				
Pendant Mount Bracket	Wall bracket for Indoor Domes	Ceiling Flush Mount Adapter for Indoor Domes	Ceiling Flush Mount Adapter for AV-Domes	Ceiling Flush Mount Adapter for Indoor PTZs
Suitable for: GCA-B4323V, GCA-B4325V, GCA-B4326V, GCA-B4327V, GCA-B5325V, GCA-B5326V, GCA-C2357V, GCA-H0325V, GCH-K0323V, GCH-K0326V, GCH-K1325V(-1), GCH-K1327V(-1)	Suitable for: GCA-B4322D, GCA-B4325D, GCA-B4326D, GCA-B4327D, GCA-H0325D, GCH-K0323D, GCH-K0326D, GCA-B032xD, GCA-B132xD, GCA-B332xD, GCH-K1325D(-1), GCH-K1327D(-1)	Suitable for: GCA-B4322D, GCA-B4325D, GCA-B4326D, GCA-B4327D, GCA-H0325D, GCH-K0323D, GCH-K0326D, GCH-K1325D(-1), GCH-K1327D(-1)	Suitable for: GCA-B4323V, GCA-B4325V, GCA-B4326V, GCA-B4327V, GCA-B5325V, GCA-B5326V, GCA-C2357V, GCA-H0325V, GCH-K1325V(-1), GCH-K1327V(-1)	Suitable for: GCI-C0735P, GCI-C0835P, GCA-C0335P
Body material: Aluminium alloy	Load max.: 2 kg	Body material: Plastic	Body material: Steel	Body material: Steel
Colour: White	Body material: Steel	Colour: RAL 9003	Colour: RAL 9010	Colour: White
Weight: 0.68 kg	Colour: White	Weight: 0.25 kg	Assembly (Template) hole size: Ø 200 mm	Weight: 0.265 kg
Dimensions (WxHxD): Ø100 x 345-550 x Ø145 mm	Weight: 0.255 kg	Dimensions (WxHxD): Ø 190 x 85 mm	Weight: 0,785 kg	Dimensions (WxHxD): Ø 179 x 132 mm
	Dimensions (WxHxD): 128 x 60 x 145 mm		Dimensions (WxHxD): Ø 250 x 113 mm	

GBR-IC02	GBR-IC05	GBR-CM02	GBR-WA02	GBR-CE01
				
Flush Mount Adapter for AV IP Dome Cameras	Ceiling Flush Mount Adapter	Corner Mount Adapter for AV IP Dome Cameras	Wall Bracket	PendantMountBracket
Suitable for: GCI-K1527V, GCI-K1587V, GCI-F1576VH, GCI-K1526V(H), GCI-K1523V, GCI-K1585V(-1) GCI-K1586V	Suitable for: GCI-K0779P	Suitable for: GCI-K1527V, GCI-K1587V, GCI-F1576VH, GCI-K1526V(H), GCI-K1523V, GCI-K1585V(-1), GCI-K1586V	Suitable for: GCI-C0745P(-1), GCI-K1779P, GCI-K2795P, GBR-AM01, GBR-AM02, GBR-AM03, GBR-AM04, GBR-CM01, GBR-PM01	Suitable for: GCI-C0745P(-1), GCI-K1779P, GCI-K2795P, GBR-AM01, GBR-AM02, GBR-AM03, GBR-AM04
Body material: Aluminium + Plastic	Body material: Steel	Body material: Aluminium	Body material: Die cast aluminium	Body material: Aluminium alloy
Colour: White	Colour: White	Colour: White	Colour: White	Colour: White
Weight: 0.38 kg	Weight: 1.44 kg	Weight: 1.16 kg	Weight: 0.60 kg	Weight: 2.2 kg
Dimensions (WxHxD): ø 200 x 80 mm	Dimensions (WxHxD): ø 276 x 167 mm	Dimensions (WxHxD): 240 x 176 x 159 mm	Dimensions (WxHxD): 104 x 127 x 184 mm	Dimensions (WxHxD): ø 50 x 500 x ø 140 mm

GBR-AM01	GBR-AM02	GBR-AM03	GBR-AM04	GBR-PM01
				
Hanging Mount Adapter	Adapter for Pelco Pendant Mount with 1,5" NPT thread	Hanging Mount Adapter	Hanging Mount Adapter	Pole Mount Adapter
Suitable for: GCI-C0835P, GCI-C0735P, GCA-C0335P, GCA-C0345P	Suitable for: GCI-C0745P(-1), GCI-K1779P, GCI-K2795P, GBR-AM01, GBR-AM03, GBR-AM04	Suitable for: GCI-K0779P	Suitable for: GCI-K1527V, GCI-K1587V, GCI-F1576VH	Suitable for: GBR-WA02
Body material: Die cast aluminium	Body material: Aluminium alloy	Body material: Die cast aluminium and steel	Body material: Die cast aluminium and steel	Pole: ø 100 to 185 mm
Colour: White	Colour: White	Colour: White	Colour: White	Body material: Steel
Weight: 0.5 kg	Weight: 0.1 kg	Weight: 0.5 kg	Weight: 0.28 kg	Colour: White
Dimensions (WxHxD): ø 140.7 X 73.9 mm	Dimensions (WxHxD): ø 55 x 51,5 mm	Dimensions (WxHxD): ø 111 X 76 mm	Dimensions (WxHxD): ø 146 X 82 mm	Weight: 1 kg
				Dimensions (WxHxD): 270 x 170 x 60 mm

GBR-CM01	GBR-RM01	GAM-B0103A	GAC-B0103A	GAC-B0203A
				
Corner Mount Adapter	Monitor Bracket	Power Supply Bracket for VESA Adapter	Clear Dome Cover for Indoor domes	Smoked Dome Cover for Indoor domes
Suitable for: GBR-WA02	Recommended Monitor Size: 25 cm ~ 48 cm (13" ~ 19")	Suitable for: GML-1730M, GML-1930M, GML-1931M	Suitable for: GCA-B4322D, GCA-B4325D, GCA-B4326D, GCA-B4327D, GCA-H0325D, GCH-K0323D, GCH-K1325D(-1), GCH-K1327D(-1)	Suitable for: GCA-B4322D, GCA-B4325D, GCA-B4326D, GCA-B4327D, GCA-H0325D, GCH-K0323D, GCH-K1325D(-1), GCH-K1327D(-1)
Body material: Steel	Vesa Mount: 75 ~ 100 mm	Vesa Mount: 75 ~ 100 mm	Material: Polycarbonate	Material: Polycarbonate
Colour: White	Load max.: 9 kg	Material: Steel	Weight: 0.05 kg	Weight: 0.05 kg
Weight: 2 kg	Colour: Black	Colour: Black	Dimensions (WxHxD): Ø 110 x 65 mm	Dimensions (WxHxD): Ø 110 x 65 mm
Dimensions (WxHxD): 222 x 204 x 117 mm	Material: Steel	Weight: 0.115 kg		
	Weight: 1.2 kg	Dimensions (WxHxD): 100 x 112.4 x 34 mm		
	Dimensions (WxHxD): 480 x 100 x 13 mm			

GAC-B0303A	GAC-B0504A	GAC-B1504A	GAC-B0604A	GAC-B0704A
				
Semi-Transparent Dome Cover for Indoor domes	Clear Dome Cover for AV Domes	Rain-Wash-Vandal Resistant Clear Dome Cover for AV Domes	Smoked Dome Cover for AV Domes	Semi-Transparent Dome Cover for AV Domes
Suitable for: GCA-B4322D, GCA-B4325D, GCA-B4326D, GCA-B4327D, GCA-H0325D, GCH-K0323D, GCH-K1325D(-1), GCH-K1327D(-1)	Suitable for: GCA-B4323V, GCA-B4325V, GCA-B4326V, GCA-B4327V, GCA-B5325V, GCA-B5326V, GCA-C2357V, GCA-H0325V, GCH-K0323V, GCH-K0326V, GCH-K1325V(-1), GCH-K1327V(-1)	Suitable for: GCA-B4323V, GCA-B4325V, GCA-B4326V, GCA-B4327V, GCA-B5325V, GCA-B5326V, GCA-C2357V, GCA-H0325V, GCH-K0323V, GCH-K0326V, GCH-K1325V(-1), GCH-K1327V(-1)	Suitable for: GCA-B4323V, GCA-B4325V, GCA-B4326V, GCA-B4327V, GCA-B5325V, GCA-B5326V, GCA-C2357V, GCA-H0325V, GCH-K0323V, GCH-K0326V, GCH-K1325V(-1), GCH-K1327V(-1)	Suitable for: GCA-B4323V, GCA-B4325V, GCA-B4326V, GCA-B4327V, GCA-B5325V, GCA-B5326V, GCA-C2357V, GCA-H0325V, GCH-K0323V, GCH-K0326V, GCH-K1325V(-1), GCH-K1327V(-1)
Material: Polycarbonate	Material: Polycarbonate	Material: Polycarbonate	Material: Polycarbonate	Material: Polycarbonate
Weight: 0.05 kg	Weight: 0.05 kg	Weight: 0.05 kg	Weight: 0.05 kg	Weight: 0.05 kg
Dimensions (WxHxD): Ø 110 x 65 mm	Dimensions (WxHxD): Ø 110 x 65 mm	Dimensions (WxHxD): Ø 110 x 65 mm	Dimensions (WxHxD): Ø 110 x 65 mm	Dimensions (WxHxD): Ø 110 x 65 mm

GAC-B0202B	GAC-B0502A	GAC-B0602A	GBR-VC02S	GBR-VC03
				
Smoked Dome Cover for Indoor PTZ Domes	Anti-Vandal Clear Dome Cover for PTZ Domes	Smoked Dome Cover for PTZ Domes	Smoked Dome Cover for AV IP Domes	Special Coated Clear Dome Cover for AV IP Domes
Suitable for: GCA-C0335P, GCI-C0835P	Suitable for: GCA-C0245P, GCI-C0745P(-1), GCI-K0779P, GCI-K1779P, GCI-K2795P	Suitable for: GCA-C0245P, GCI-C0745P(-1), GCI-K0779P, GCI-K1779P, GCI-K2795P	Suitable for: GCI-K1527V, GCI-K1587V, GCI-F1576VH, GCI-K1526V(H), GCI-K1523V, GCI-K1585V(-1), GCI-K1586V	Suitable for: GCI-K1527V, GCI-K1587V, GCI-F1576VH, GCI-K1526V(H), GCI-K1523V, GCI-K1585V(-1), GCI-K1586V
Material: Polycarbonate	Material: Polycarbonate	Material: Polycarbonate	Material: Polycarbonate	Material: Polycarbonate
Colour: smoked/tinted	Colour: Clear Bubble	Colour: smoked/tinted	Colour: smoked/tinted	Colour: Clear Bubble
Weight: 0.075 kg	Weight: 0.165 kg	Weight: 0.165 kg	Weight: 0.056 kg	Weight: 0.056 kg
Dimensions [WxHxD]: Ø 130x60 mm	Dimensions [WxHxD]: Ø 152 x 70 mm	Dimensions [WxHxD]: Ø 152 x 70 mm	Dimensions [WxHxD]: Ø 121 x 64 mm	Dimensions [WxHxD]: Ø 121 x 64 mm

CABLES & ACCESSORIES

GRUNDIG SUPPORTS ITS PRODUCT PORTFOLIO WITH
A COMPREHENSIVE RANGE OF ACCESSORIES.
GRUNDIG HAS A SOLUTION FOR EVERY APPLICATION.





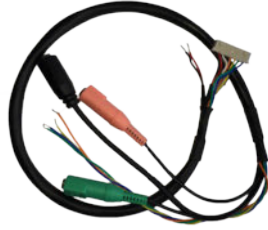

GAC-C2030A

Optional Cable for Fisheye Cameras

- Alarm and Audio In/Out-, Power- Connection Cable

SPECIFICATIONS

Suitable for:	GCI-G1536F, GCI-M0566F, GCI-G0862F
Audio Input/Output:	Line In/Line Out (two way Audio), 2 Stereo jack Ø3.5mm
Power Connector:	DC Femal connector 5.5/2.1mm
Alarm Input/Output:	Input 2 wire, Output 2 wire
Material:	Polycarbonate and copper
Dimensions (WxHxD):	500 mm



GLE-B2800M

1/2.7" Megapixel Board Lens

- Wide Angle Lens
- Focal length 2.8 mm, 120° Horizontal Angle of View for 1/2.7" Format

SPECIFICATIONS

Suitable for:	GCI-H2812W; GCI-K2812W; GCI-F2812W; GCI-H0812W; GCI-K1812W
Max. Image Format:	1/2.7"
Focal Length:	2.8 mm
Aperture Ratio:	F 1.2
Horizontal Viewing Angle:	120°
Lens Mount:	M12
Minimum Object Distance:	0.15 m
Resolution:	2 Megapixel
Operating Temperature:	-20°C ~ +60°C
Weight:	0.062 kg
Dimensions (WxHxD):	Ø 110 x 60 mm



GKB-A0110M

Keyboard with 3D joystick

- Auto Protocol Search Function for easy installation
- Control DVR and PTZ separately
- Long distance control, up to 1 Km on RS-485 communication
- Durable 3-axis PTZ joystick

SPECIFICATIONS

Suitable for:	GRH-K1104B, GRH-K2108B, GRH-K4116B, GRX-K4116A
Serial Interface(s):	1x RS-232, 1x RS-485
Protocol:	Grundig proprietary
Multi protocol (camera):	Pelco-D, Pelco-P, Panasonic, Samsung, DM, SonyD70, VCL, MIKAMI, CBC, B01, B02, SonyD70_R, EZ, VC, LILIN
Baud Rate:	1,200 ~ 19,200bps
Control:	Up to 99 DVRs
LCD Panel size:	2x16 Gray Graphic LCD
Pan/Tilt Control:	Pan (Left/Right), Tilt (Up/Down)
Lens Control:	Iris (Close/Open), Focus (Near/Far), Zoom (Tele/Wide)
DVR Control:	RW, Stop, Play, FF, Rec, PTZ, Menu, Search, Backup, Monitors
PTZ Control:	Auto PAN, Preset, Sequence and Cruise Function Support
Humidity:	20 ~ 70%RH
Storage Temperature:	-40°C ~ +70°C
Operating Temperature:	-10°C ~ +50°C
Supply Voltage:	12 VDC power adaptor included
Power Consumption:	1.5 W
Weight:	2.5 kg
Dimensions (WxHxD):	299 x 94 x 188.5 mm

DIMENSIONS (MM)

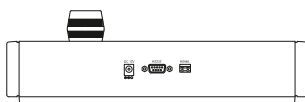
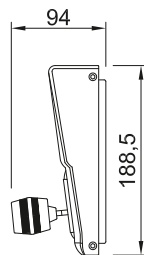
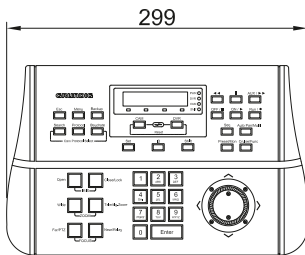



GKB-A0040P

Camera Remote Controller for Cameras with Coaxitron

- Controlling distance up to 200m over coax cable

SPECIFICATIONS

Suitable for:	For all analog fix Cameras
Control:	Coaxial with Coaxitron protocol (32Bit)
OSD Control:	Power On/OFF, Arrows (up,down,left, right), Enter and Exit button
Lens Control:	Focus (Near/Far), Zoom (Tele/Wide), Auto Focus
Pan/Tilt Control:	Pan (Left/Right), Tilt (Up/Down)
Transmission Distance:	max. 200m
Humidity:	20 ~ 70%RH
Storage Temperature:	-40°C ~ +70°C
Operating Temperature:	-10°C ~ +50°C
Supply Voltage:	Included Battery 2,3V ~ 3V (CR2025)
Weight:	0.08 kg
Dimensions (WxHxD):	54 x 86 x 7 mm

DIMENSIONS (MM)

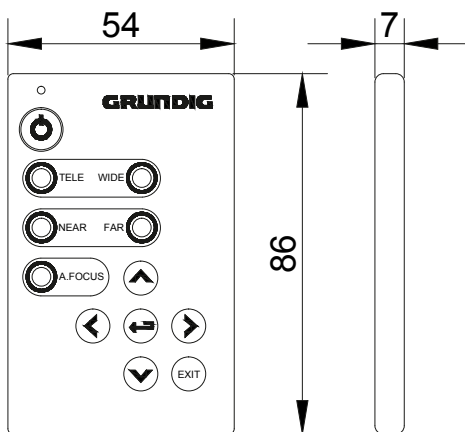



GDS-R04A

External Storage for GDV-Series DVR

- Grundig DVR external storage expansion unit (up to 8TB)
- Cascade up to 8 devices
- Data-loss protection against power failure

SPECIFICATIONS

Suitable for:	GRH-K1104B, GRH-K2108B, GRH-K4116B
Operating System:	Embedded Linux
Recording Speed:	10 MB/sec
Data Mirroring:	Software based
Rack Mount:	19" Rack mounting brackets provided.
Interfaces:	RS-232, RJ45 (DVR Connection), RJ45 (Cascade)
Operating Temperature:	5°C ~ +45°C
Harddisk bay:	4x Hot Swap SATA bays
Max. Storage Capacity:	8 TB
Power Consumption:	<85 W
Weight:	5.5 kg
Dimensions (WxHxD):	430x44x362 mm

DIMENSIONS (MM)

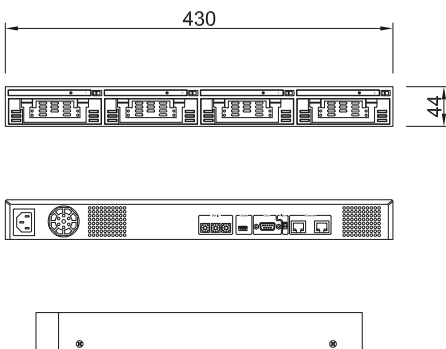

TERMS OF DELIVERY

Orders are only accepted subject to the Trading Conditions of ASP AG (Grundig Security, hereinafter called the "Supplier"). Purchasers of Supplier goods will, on accepting delivery, be deemed to have agreed that any printed conditions on their order or other documents shall only be binding where they are not at variance with these terms and conditions. Any buyer who objects to these terms below must, prior to delivery of goods, inform the Supplier of the objections in writing whereupon the order shall be deemed to be cancelled unless any proposed variation is accepted in writing by a Director of the Supplier.

1. **PRICES.** Prices charged for orders will, unless otherwise specified, be those ruling at the date of acceptance of that order. Quantity rates may apply once to each individual order and each delivery. Orders and deliveries may not be aggregated to obtain quantity rates. Prices quoted are exclusive of Value Added Tax. All prices quoted and charged are subject to payment being made within these terms. In the event of payment being overdue by 30 days or more then such prices are liable to re-calculation at the Supplier's pricing ruled in its price list current at the end of 30 days.

2. **ORDERS.** All orders shall be subject to the Purchaser being credit worthy, as determined by the Supplier. An order is only formerly accepted by the Supplier when a delivery date for the order is confirmed and communicated to the Purchaser. From time to time, upon request by the Supplier, the Purchaser shall furnish the Supplier with such financial information requested by the Supplier as will enable the Supplier to evaluate the Purchaser's financial status.

3. **SHIPMENT.** Shipment will only be made by the method of the Supplier's choice, unless otherwise agreed. Shipment will be made to any one of the Purchaser's permanent addresses. Every effort will be made to effect delivery on the delivery date communicated, or to any programme of dates agreed. However, no guarantee of delivery dates can be given and time of delivery is not of the essence of the contract. Failure to deliver on the communicated date shall not invalidate the contract or any remaining or outstanding deliveries.

4. **PAYMENT.** All monies are due to be paid not later than 30 days from the end of the month following the date of invoice, unless otherwise agreed in writing. Payments shall become immediately due upon commencement of any proceedings or any commission of any act in which the Purchaser's insolvency is involved.

5. **TITLE TO GOODS.** Until the Supplier has been paid in full for goods comprised in the order or in any other sales contract between the Supplier and the Purchaser or until title to goods is in terms relinquished to the Purchaser by the Supplier by writing under the personal hand of a / the Director of the Supplier;

a) The goods comprised in the order remain the Supplier's property and the Supplier reserves the right to dispose of the goods as the Supplier sees fit.

b) The Supplier may repossess (and for this purpose follow or trace) the goods at any time from the Purchaser, if in his possession, if the Supplier considers the amount outstanding is in excess of the credit limit and overdue for payment. The Supplier, its servants and agents may enter the Purchaser's premises where the Supplier has reason to believe any of the goods are situated.

c) The Purchaser as bailee undertakes to keep the goods safe and in good order and condition and clearly identified as the Supplier's property.

d) Should the Purchaser have passed the goods or any part of them to a third party (or have incorporated them in work for a third party) this will be deemed to have been done as the Supplier's agent only and any sums received by the Purchaser in respect of such goods or such work shall be held in trust for the supplier until all sums due to the Supplier are discharged.

e) Upon commission of any act of bankruptcy by an individual Purchaser the immediate repossession of the goods shall forthwith, automatically, revert to the Supplier.

f) All costs (including legal fees) occasioned in the recovery of goods shall be paid by the Purchaser.

6. **WARRANTY.** A warranty applies only to the Purchaser from the Supplier and where the goods are covered by a warranty. The warranty period for goods is 3 years, except for fully functional domes and recording equipment hard drives where the warranty is 1 year. The terms of such warranty shall be deemed to be part of these conditions. The Supplier warrants all goods to be free from defects in material and workmanship under normal use, provided the products have been installed and operated in accordance with the instruction manual. The commencement date for all warranties is the date of delivery to the Purchaser from the Supplier. The Supplier makes no other warranty, express or implicit, with respect to the goods, their marketability, quality or fitness for any particular use or purpose. In particular, but without prejudice, to the general provisions of these conditions no responsibility is assumed for incidental or consequential damage by reason of any warranty expressed or implied.

7. **CLAIMS.** Claims may be made subject to the Purchaser;

a) Examining the goods on their delivery for any obvious damage or shortage and reporting any damage or short delivery in writing to the Supplier and the carrier within five days of the delivery date.

b) Reporting non-delivery by telephone (and confirmed in writing) to the Supplier within 10 days of the invoice date or expected delivery date. If the Purchaser fails to give notice or to report in accordance with these terms or shall deal with goods in any manner or if there shall be any conduct by the Purchaser inconsistent with rejection of the Goods, then the Goods of the quality specified in the contract shall be deemed to have been delivered to the Purchaser. No claim or rejection, properly made pursuant to these Conditions of Supply in respect of any part delivery of Goods shall be a ground for cancellation of the contract or order.

8. **RETURNS.** Returns for credit are only permitted after the Supplier has provided a Returns Authorisation (RA) number. Such returns must be sent to the Supplier with freight paid in an unused condition. A re-stocking charge of up to 15% will be applied to all returns. A higher rate may apply if the return requires re-packaging. Returns on products over 3 years old will not be accepted. No software on which seals have been broken can be returned for credit. Please note Software Licenses are non-returnable.

9. **RIGHT OF CANCELLATION.** Rights of cancellation of the Supplier will become operable if the Purchaser should fail to meet his obligations as they fall due for any reason or if any distress or execution shall be levied upon the Purchaser's property or if the Purchaser shall commit an act of bankruptcy or being a limited company any resolution or petition to wind up its business shall be passed or presented (excepting winding-up for the purposes of reconstruction) or if a receiver of such company's undertaking property or assets shall be reimbursed for any fair and reasonable costs occasioned due to such cancellation.

10. **LIABILITY.** The Supplier shall under no circumstances be liable for any consequential or indirect damage or loss, however caused, including (but not restricted to) loss of profits, loss of goodwill, damage to trading relationships and financial loss. The Supplier's liability in respect of all other losses shall be limited to the invoiced value of the relevant order.

11. **FORCE MAJEURE.** The Supplier shall not be responsible or liable for its failure to perform its obligations, if such failure is beyond the control of the Supplier, whether caused by acts of God, unavailability or shortages of materials or energy necessary to produce and/or deliver goods by usual modes of transportation, fire, flood, war, embargo, strikes, labour disputes, explosions, riots, of Laws, rule regulations, restrictions or orders of any Governmental authority, or any other cause, other than financial, beyond the control of the Supplier and its suppliers.

12. **RELATIONSHIPS.** Relationship is that of the Supplier and Purchaser, and neither the Supplier or the Purchaser nor any of their employees, customers or agents shall be deemed to be the representative, agent or employee of the other for any purpose whatsoever, nor shall any of them have any right or authority to assume or create an obligation of any kind or nature, express or implied, on behalf of the other, nor to accept service of any legal process addressed to or intended for the other, nor to pledge the other's credit. The Purchaser warrants and represents that there is no legal impediment preventing acceptance of these terms and conditions of supply and that the acceptance of these has been duly authorised and that the obligations do not conflict with or violate any terms or conditions of any other agreement or commitment by the Purchaser.

13. **ARBITRATION.** These Terms & Conditions are governed by German law. Any dispute not settled by the parties shall be submitted to arbitration at the Düsseldorf Chamber of Commerce in Germany and shall be settled according to the laws of Germany.

14. **ADVANCED REPLACEMENTS AND REPAIRS.** Advanced replacements only apply on products which are no older than 3 months of the invoice date. Repairs only apply on products which are no older than their warranty period of 1 or 3 years.

15. **ERRORS AND OMISSIONS.** The Supplier makes every effort to ensure that all prices and descriptions quoted in printed form and on its website are correct and accurate. In the case of an error or omission, the Supplier will be entitled to rescind the contract, notwithstanding that he has already accepted the Purchaser's order, and the Supplier's liability in that event will be limited to the return of any money the Purchaser has paid in respect of that order.

PRODUCT INDEX

MODEL	PAGE	MODEL	PAGE	MODEL	PAGE
GAC-B0103A	122	GCA-B4326D	74	GCI-N0503B	16
GAC-B0202B	123	GCA-B4326V	79	GDS-R04A	129
GAC-B0203A	122	GCA-B4327D	76	GEC-D2201AR-1	112
GAC-B0303A	122	GCA-B4327V	82	GKB-A0040P	128
GAC-B0502A	123	GCA-B5325V	83	GKB-A0110M	127
GAC-B0504A	122	GCA-B5326V	81	GLE-B2800M	126
GAC-B0602A	123	GCA-C0245P	90	GML-1030MD	104
GAC-B0604A	122	GCA-C0335P	89	GML-1730M	105
GAC-B0704A	122	GCA-C2357V	84	GML-1930M	106
GAC-B1504A	122	GCA-H0325D	72	GML-1931M	107
GAC-C2030A	126	GCA-H0325T	85	GML-2231M	108
GAM-B0103A	122	GCA-H0325V	77	GML-2431M	109
GAX-P9830A	114	GCH-K1305B-1	49	GMT-1031P	103
GBR-AM01	121	GCH-K1325D-1	50	GRA-D1104B	95
GBR-AM02	121	GCH-K1325V-1	52	GRA-D2208A	98
GBR-AM03	121	GCH-K1327D-1	51	GRA-D2208B	96
GBR-AM04	121	GCH-K1327T-1	54	GRA-D4416A	99
GBR-CE01	121	GCH-K1327V-1	53	GRA-D4416B	97
GBR-CE02	120	GCI-C0745P-1	35	GRH-K1104B	59
GBR-CM01	122	GCI-F0505B	14	GRH-K2108B	60
GBR-CM02	121	GCI-F0576TH	33	GRH-K4116B	61
GBR-FB03	120	GCI-F0676D	24	GRI-K1104A	43
GBR-IC01	120	GCI-F1576VH	29	GRI-K2208A	44
GBR-IC02	121	GCI-F2812W	20	GRI-K4416A	45
GBR-IC04	120	GCI-G0509B	15	GRX-K4416A	62
GBR-IC05	121	GCI-G1536F	25	GTH-C0041C	116
GBR-IC06	120	GCI-H2505B	8	GTH-K0010M	116
GBR-PM01	121	GCI-H2812W	18	GTH-K0011E	117
GBR-PM02	120	GCI-K0589T-1	32	GTI-F0022C	113
GBR-RM01	122	GCI-K0622D	21	GTI-F0025N	113
GBR-VC02S	123	GCI-K0779P	36	GTI-F0811E	114
GBR-VC03	123	GCI-K1503B	13	GTI-F1026F	115
GBR-WA02	121	GCI-K1505B	9		
GBR-WA03	120	GCI-K1526T	30		
GBR-WA04	120	GCI-K1526TH	31		
GBR-WA06	120	GCI-K1527V	27		
GBR-WB02	120	GCI-K1555Z	17		
GCA-B1002B	68	GCI-K1577TH	34		
GCA-B1005B	69	GCI-K1587V	28		
GCA-B1302B	70	GCI-K1603B	12		
GCA-B1305B	71	GCI-K1627D	22		
GCA-B2326T	86	GCI-K1677D	23		
GCA-B2357T	88	GCI-K1779P	37		
GCA-B3326T	87	GCI-K2505B	10		
GCA-B4322D	73	GCI-K2795P	38		
GCA-B4323V	78	GCI-K2812W	19		
GCA-B4325D	75	GCI-K3505B	11		
GCA-B4325V	80	GCI-M0566F	26		

